

Uniclass L7315	May 2017
CI/SfB (52.6)	

ACO Building Drainage

Drainage Systems



Product catalogue

ACO Modular 125⁺

Stainless Steel Channel Drainage System





ACO Building Drainage

Our built environment is becoming ever more complex. Applications are becoming more sophisticated and the increasing pressure of regulations and standards makes achieving design, performance and financial goals ever tougher.

Our mission: to eliminate design risk, to reduce installed and life cost and to deliver exceptional finish and performance in every product application.

Our global resources and fabrication capacity make it possible for us to deliver best value, both with our standard products and with our engineered solution designs. Confidence is further assured with quality systems that are in accordance with ISO 9001-2008.

ACO Building Drainage is a division of ACO Technologies plc and part of the worldwide ACO Group. The Group has sales in excess of £600 million worldwide with production facilities in the UK, Germany, France, Switzerland, Denmark, Spain, Poland, Czech Republic, Australia and the USA. In total more than 4200 people are employed in over 40 countries throughout the world.

ACO Building Drainage
Enquiries Team:
 Tel: + 44 (0)1462 810421
 Email: abdestimating@aco.co.uk

- A complete pricing service to merchants, contractors and clients.

ACO Building Drainage
Customer Services Team:
 Tel: +44(0)1462 810411
 Email: abdcommercial@aco.co.uk

- Product availability, delivery lead times, and all other queries including collections, returns and complaints.

ACO Building Drainage
Design Services Team:
 Tel: +44(0)1462 810431
 Email: abdtechnical@aco.co.uk

- Technical and installation advice.
- Detailed design and 'Value Engineering' advice.
- Hydraulic calculations and AutoCAD drawings.
- Advice on the suitability of ACO equivalent products.

ACO Building Drainage
Marketing and Media Support
 Tel: +44(0)1462 810400
 Email: abdmarketing@aco.co.uk

- For all product brochures, imagery or merchandising material requests.



collect:

- Stainless Steel and Galvanised Steel Channels
- Stainless Steel Gullies
- Pipe System
- Roof / Balcony Drainage
- Wetroom & Shower Drainage



clean:

- Grease Management Systems



hold:

- Anti-flood Backflow Protection Systems



release:

- Lifting Stations

Office address and contact details:

ACO Building Drainage
 ACO Business Centre
 Caxton Road
 Bedford
 Bedfordshire
 MK41 0LF

Tel: +44(0)1462 810400
 Fax: +44(0)1462 851490
 Email: abdinfo@aco.co.uk

Company Registration No: 1854115
 VAT No: GB 650 7977 05

www.acobd.co.uk

For quick access to our website, scan:



Contents

System Overview	
System Overview	4
Typical Applications	5
Features and Benefits	6
Channel Edge Options	10
Foul Air Traps	11
Grating Options	12
Load Class and Wheel Loads	14
Specification and Product Selection	15
Technical Data	
ACO Modular 125 ⁺ Spigot Outlets	18
ACO Modular 125 ⁺ Spigot Outlet Accessories	20
ACO Modular 125 ⁺ Discreet Channel Gullies	21
ACO Gully 157 for use with Discreet Channel Gully	22
ACO Gully 157 Accessories / Replacements	24
ACO Modular 125 ⁺ Gully Outlets	25
ACO Gully 218 for use with One Way and Two Way Gully Tops	27
ACO Gully 218 Accessories / Replacements	29
ACO Modular 125 ⁺ Level Invert Channels	30
ACO Modular 125 ⁺ Sloping Invert Channels	31
ACO Modular 125 ⁺ Corner and Branch Units	32
ACO Modular 125 ⁺ End Plates and PVC Infill	33
ACO Vinyl Seal® and Grating Lockings and Security	34
ACO Modular 125 ⁺ Channel Gratings	35
ACO Gully 218 Gratings for use with One Way and Two Way Gully Tops	40
Installation, Care and Maintenance	
ACO Modular 125 ⁺ Channel and Gully Installation Recommendations	41
Floor Finishes	44
Grate Installation	44
ACO Vinyl Seal® Installation Recommendations	46
Care and Maintenance of ACO Modular 125 ⁺	48
Stainless Steel	
Stainless Steel Explained	49
Stainless Steel Finishing Processes	50
Corrosion Resistance Chart	51
System Characteristics	
System Characteristics	53
Model Specification Clause	53
EU Conformity	53
Associated ACO Building Drainage Product Ranges	
Associated ACO Building Drainage Product Ranges	54

System Overview

The ACO Building Drainage Modular 125 stainless steel linear drainage system takes full advantage of the significant investment in our state-of-the-art manufacturing plant and offers improved performance together with a fully flexible stainless steel drainage system suitable for most applications – off the shelf.

Significant system advantages include:

- Fully tested and classified to BS EN 1433 – Drainage channels for vehicular and pedestrian areas for enhanced operational confidence.
- Fully pickle passivated (see page 50).
- Vee-bottomed profiled channel for enhanced flow efficiency at low flow rates, for a cleaner, hygienic system.
- Wide range of constant depth and sloping invert channels and accessories.
- Wide variety of invert depths and channel falls to suit most applications.
- Unique optional grating security locks.
- Wide grating choice.
- Lightweight channel sections minimise the risk to construction employees during installation.

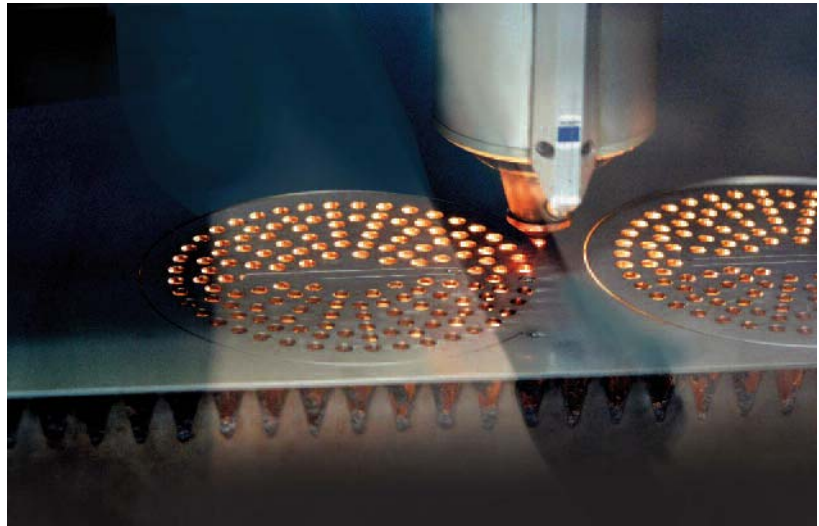

ACO Modular 125+ is manufactured in corrosion resistant 304 grade austenitic stainless steel that is fully pickle passivated to remove embedded iron and chromium-depleted weld-zones.

The enhanced corrosion resistance and extreme durability of fully pickle passivated stainless steel make the material suitable for many applications demanding a reliable, long-life performance.

A key attribute of stainless steel that is often overlooked is that the raw material is manufactured from a minimum of 70% recycled materials, therefore significantly contributing to a sustainable environment. Additionally, stainless steel is 100% recyclable if products are ever removed or come to the end of their working life.



In particularly chemically aggressive applications, Modular 125 is available in 316 grade stainless steel to special order.

Typical Applications

Food Processing



Brewing, Bottling and Canning



Retail



School and Leisure



Chemical and Pharmaceutical



Human and Animal Health Care



Note:

ACO Modular 125+ in 304 stainless steel is not suitable for swimming poolside or changing areas which have no dividing wall from the pool area. For these applications the drainage channel can be manufactured in stainless steel 316.

Please contact the ACO Building Drainage Team on **01462 810421** or e-mail abdestimating@aco.co.uk for further details.

Modular 125⁺ Introduction Features and Benefits

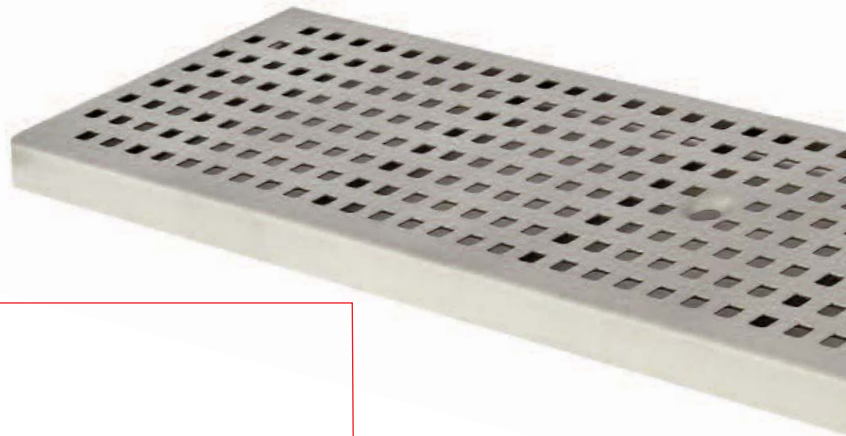

Modular 125⁺

The 125mm wide, modular channel system for the flexible, off-the-shelf drainage solution. There are a wide variety of channel options:

- Level or sloping straight
- Level corner units
- Level branch units
- Various outlet options

ACO also offers Modular 125⁺ specials if a different configuration is required.

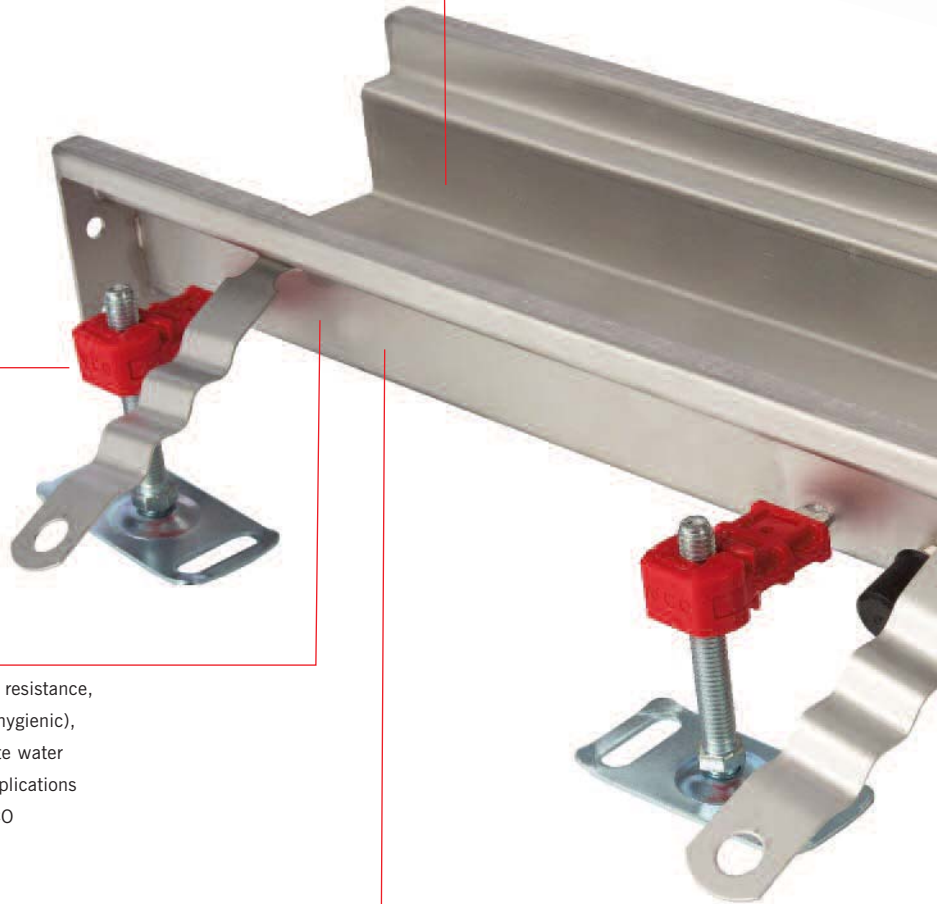

Levelling Feet **NEW!**

A new plastic clip is designed to allow free movement of the threaded levelling feet. Once the clip is fully secured, a fine adjustment is still possible using a screw driver.

Material

The properties of stainless steel, such as corrosion resistance, non-magnetic, durable and smooth (easy to clean/hygienic), makes it the most suitable material for use in waste water applications. In a high saline environment or in applications where a higher chemical resistance is required, ACO recommends using Stainless Steel, AISI 316.

Pickle passivate

All ACO stainless steel AISI 304 channels are fully pickle passivated to restore its corrosion resistance and optimum durability.

Outlet Options

There are 2 outlet options available:

1. For direct connection to the waste water pipe (Spigot Outlet)
2. To be used in combination with gullies;
 - Discreet channels
 - One- or two-way gully tops

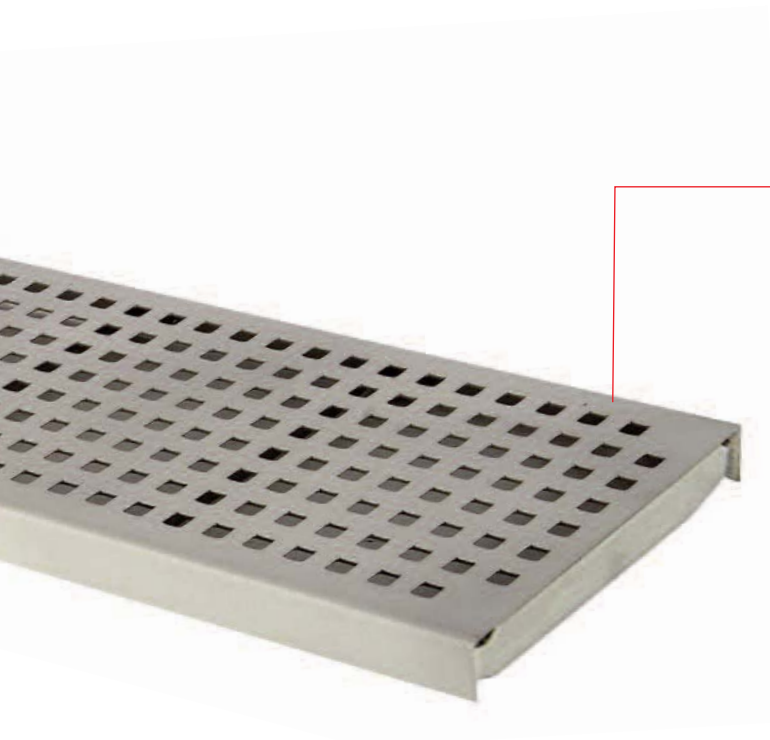

Gratings

A large selection of gratings stainless steel, composite or plastic. Unlocked gratings make it easy to get access to the channel and lockable gratings prevent unauthorised removal.

Gratings are classified according to the suitability for type of foot travel.



Products recommended for barefoot applications e.g. shower areas and changing rooms.



Products recommended for animal friendly environments e.g. kennels and catteries.



Products not suitable for barefoot applications or animal friendly environment.



Fixings

Channels come complete with neoprene gaskets and fixings.

Channel Edge:

The channel comes standard without an edge in-fill. Depending on the required load class or flooring type, an in-fill is used to accommodate the required Load Class.



Edge in-fill ensures stable and durable transmission of applied loads between the gully and surrounding floor, which

helps minimise the risk of floor cracks that can harbour microorganisms.

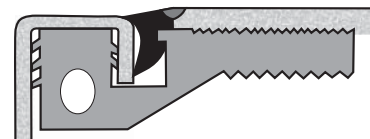

ACO Vinyl Seal® is ideal for flexible/vinyl sheet flooring applications. This edge in-fill can be used to create a fully welded system that is watertight and improves hygiene performance by eliminating cumbersome mechanical clamping systems.



Features and Benefits

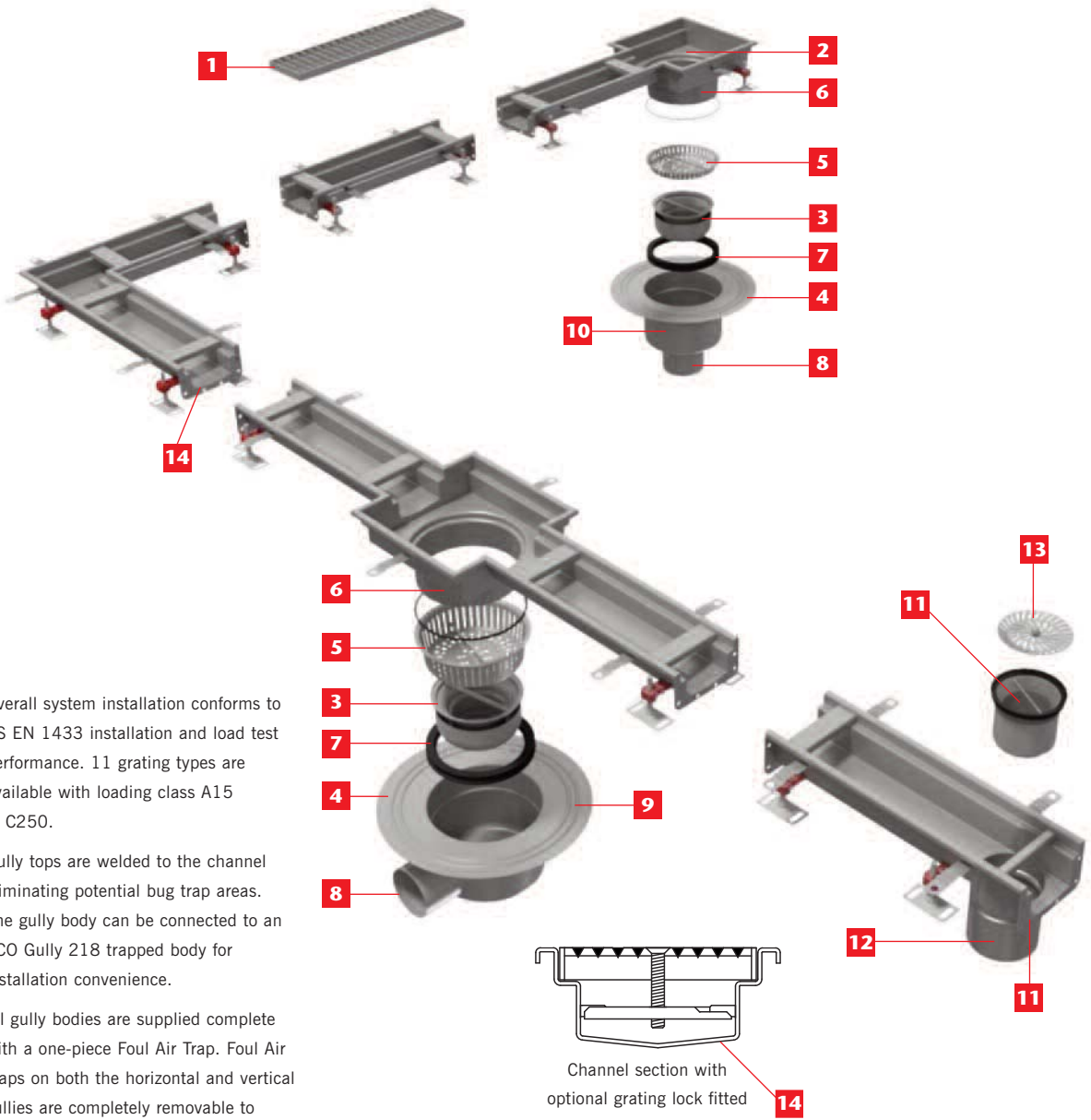

- 1** Overall system installation conforms to BS EN 1433 installation and load test performance. 11 grating types are available with loading class A15 to C250.
- 2** Gully tops are welded to the channel eliminating potential bug trap areas. The gully body can be connected to an ACO Gully 218 trapped body for installation convenience.
- 3** All gully bodies are supplied complete with a one-piece Foul Air Trap. Foul Air Traps on both the horizontal and vertical gullies are completely removable to allow easy rodding access to the connecting pipework for cleaning and maintenance. 50mm trap water seal conforms to BS EN 1253.
- 4** Flow rate up to 6.3 l/s for vertical and for 4.5 l/s for horizontal is available from outlet gullies.
- 5** An optional silt basket collects debris effectively.
- 6** Telescopic gully arrangement provides variable invert connection capability.
- 7** All gullies supplied with integrated seal to gully top.

- 8** Chamfered spigot outlets provide easy push-fit connection to drainage pipes.
- 9** All gully bodies available with optional damp proof membrane attachment options.
- 10** Gullies have deep rounded contours to deter silt build up and make cleaning easier.
- 11** 110mm dia spigot outlets with optional in-line Foul Air Trap provide a 1.2 l/s flow capacity.

- 12** Spigot outlets can be supplied with a Foul Air Trap which has a water trap depth of 50mm meeting the requirements of BS EN 1253. The Foul Air Trap allows for an optional sieve to be used.
- 13** Optional sieve for 110mm diameter spigot outlet. Debris basket can be supplied if Foul Air Trap is omitted.
- 14** Vee-bottomed channel profile enhances flow efficiency at low flow rates for a cleaner, hygienic system.

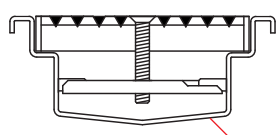

Channel section with optional grating lock fitted **14**

Features and Benefits

- 15** Discreet channel gully outlets provide greater flow than a spigot outlet and also maintain a consistent width to the channel where aesthetic considerations are important.
- 16** The discreet channel gully can be connected to ACO Gully 157 trapped body for installation convenience.
- 17** Discreet channel gully flow rates up to 4.5 l/s and 2.8 l/s for vertical and horizontal outlet gullies respectively.
- 18** Channel and gully tops finished with a brushed 14mm wide edge detail providing an attractive and practical interface with all surrounding floor finishes. All products are compatible with the optional ACO Vinyl Seal® for a fully welded flexible floor attachment solution.
- 19** Channels are supplied complete with removable spacer bars to aid installation. They are easily removed prior to grating installation.
- 20** Concrete anchor ties are supplied welded to the channel for increased operational robustness following installation.
- 21** Levelling feet assist in setting the channel out to finished floor level and provide a convenient concrete anchor.
- 22** Corner units accommodate standard 500mm grating lengths.
- 23** Branch units accommodate standard 500mm grating lengths.
- 24** Flange plates are welded to each channel section and allow multi-point clamping of the neoprene sponge gasket for a waterproof seal.
- 25** An optional discreet channel silt basket collects debris effectively.
- 26** Closing end plates available for all level invert channel depths.
- 27** Outlet end cap available to special order.

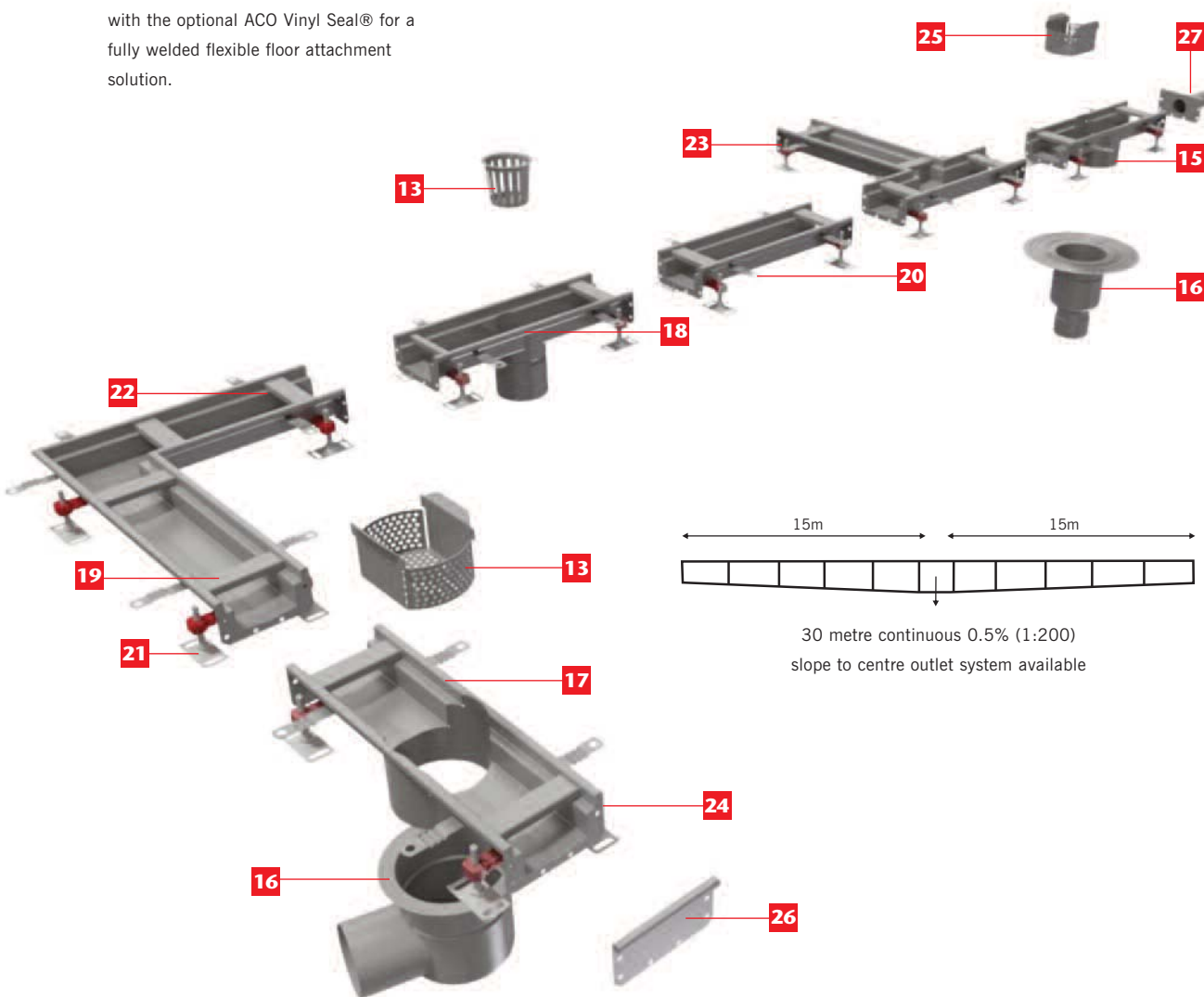

Channel Edge Options

Modular 125 channels are available with different edge details to suit varying load requirements and the surrounding floor material.

Standard Channel



Suitable for tiled, concrete and epoxy resin floors in pedestrian and light industrial applications. Suitable for Load Class A15 to BS EN 1433.

- 1** Channel edge
- 2** Mastic sealant
- 3** PVC infill
- 4** Standard channel with vee profile
- 5** ACO Building Drainage VinylSeal® for welded vinyl sheet flooring

PVC Infill



The underside of the channel can be infilled with a PVC strip to provide additional strength in dense traffic areas. PVC Infill is supplied loose for installation on site. Required for Load Class B125 and above (BS EN 1433).

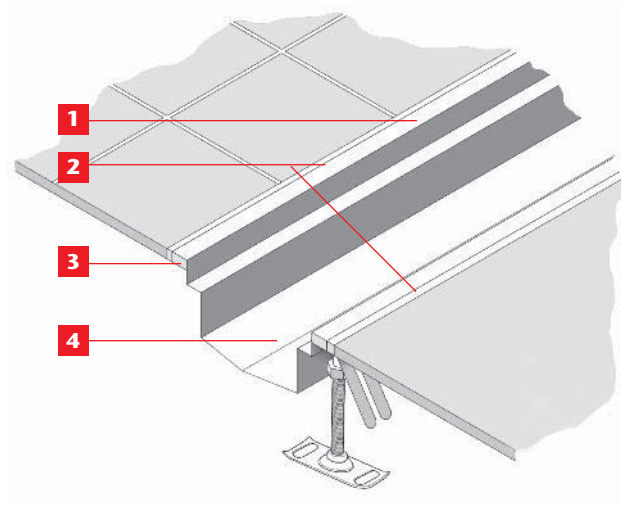

ACO Vinyl Seal®

Ideal for vinyl/flexible sheet flooring applications. The fully welded system is watertight and improves hygiene performance by eliminating cumbersome mechanical clamping systems.

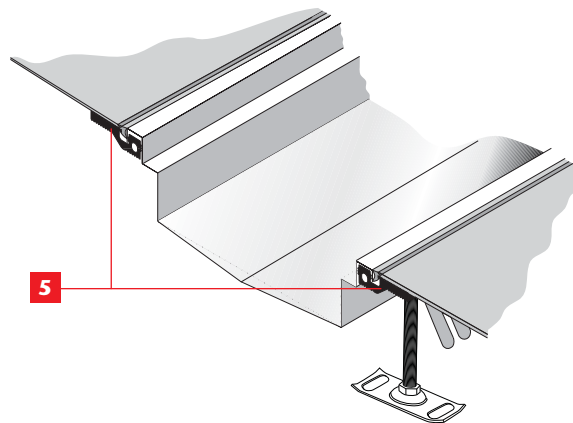

Note:

ACO Vinyl Seal® is **not suitable for wooden or suspended floors.**

Contact the ACO Building Drainage Team on 01462 810421 or email abdestimating@aco.co.uk for assistance.

Foul Air Traps

- 1** Foul Air Traps (FATs) are devices which contain a water seal and prevent gasses and stale air from passing back from stagnant or dirty water within connecting pipework.
 - 2** A water seal level is maintained in the gullies by means of weirs formed by the trap unit fitted into the gully body. (See Diagram)
- The Foul Air Traps are fully removable to allow for rodding of connecting pipework and easy cleaning of the gully body.

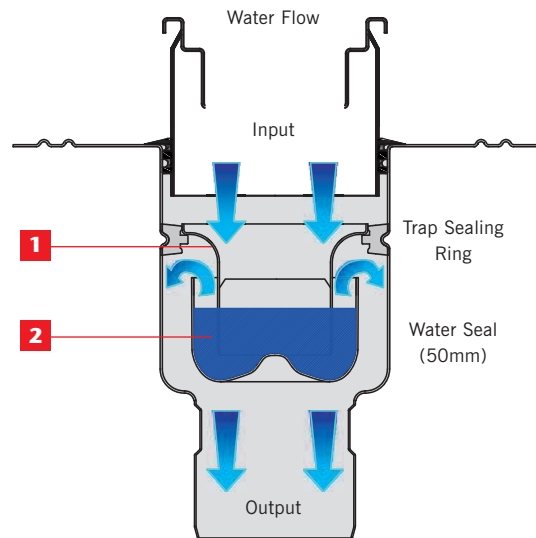

ACO Modular 125+ Vertical Outlet Gully

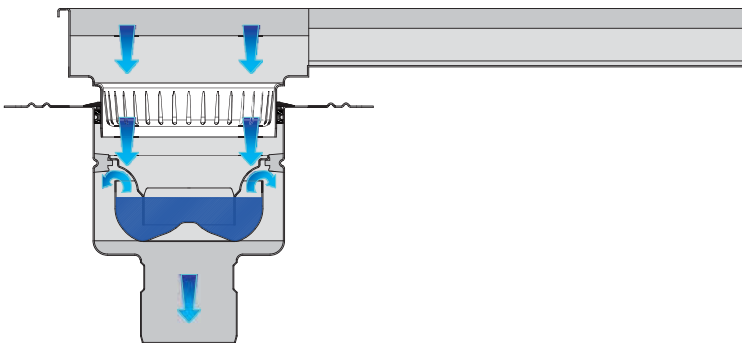

Discreet Channel Vertical Outlet

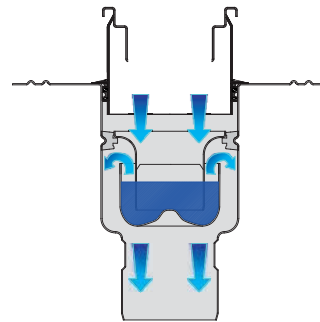

ACO Modular 125+ Horizontal Outlet Gully

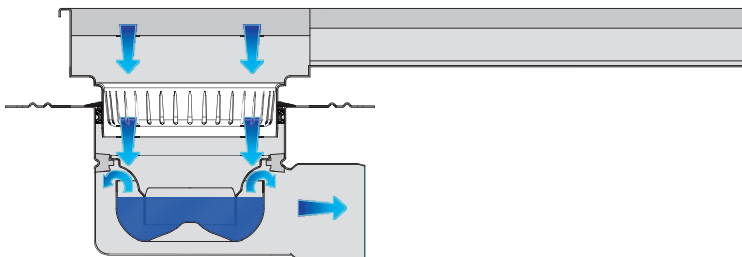

Discreet Channel Horizontal Outlet

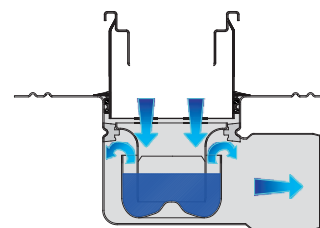

- 3**  Indicates water flows through foul air traps

Note:

50mm water seal depth.

Helpful Hint: Foul Air Traps can dry out if used infrequently

Grating Options

Plain Mesh

Load class A15 & C250
Electropolished 304 stainless steel

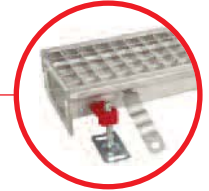
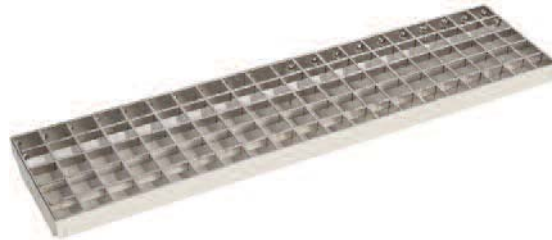

Slip resistant mesh

Load class A15 & C250
Electropolished 304 stainless steel

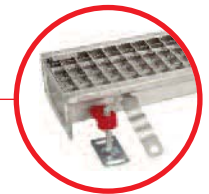
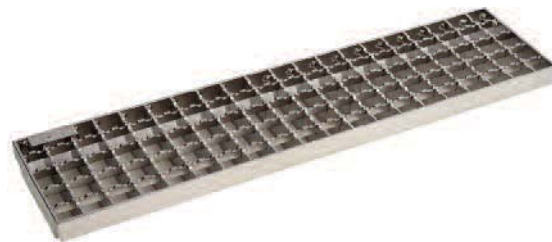

Heelsafe

Load class B125
Linished 304 stainless steel
Locking option available

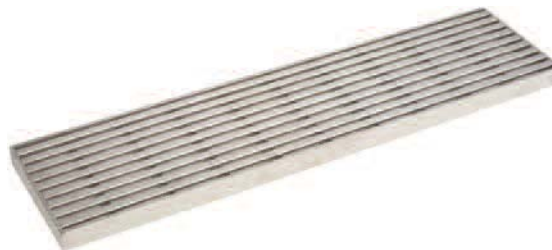

Ladder – reversible plain or slip resistant

Load class C250
Pickle passivated 304 stainless steel

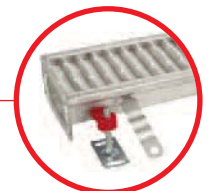

Perforated

Load class C250
Pickle passivated 304 stainless steel
Recess for optional grating locking provided

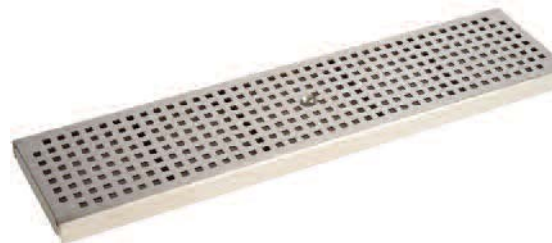

Slotted Locked

Load class A15 & C250
Pickle passivated 304 stainless steel
Recess for optional grating locking provided



Note:

All grating designs load tested and certified to BS EN 1433. Declaration of Conformity available on request. Gratings supplied as standard without locking. Details of grating locking kits available are described on page 34. Please refer to page 33 for PVC Infill requirement for applications at Load Class B125.

Grating Options

Quadrato – plain or slip resistant

Load class A15
 Finished 304 stainless steel
 Locking option available

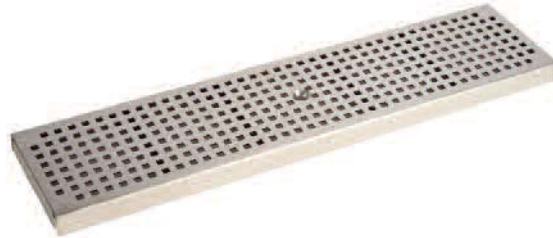

Intercept – plain or slip resistant

Load class A15
 Finished 304 stainless steel
 Locking option available

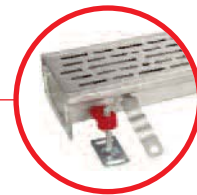
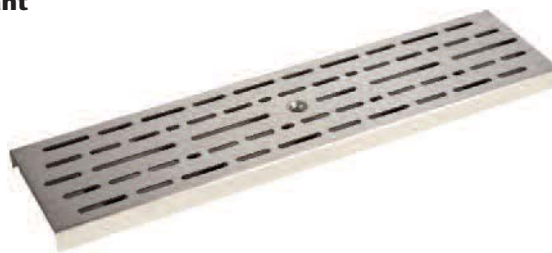

Heelsafe external

Load class B125
 Finished 304 stainless steel
 Recess for optional grate locking provided

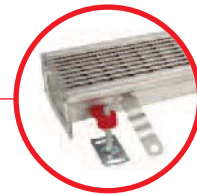

White Plastic

Load class A15
 Polyethylene

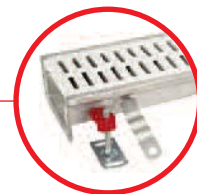
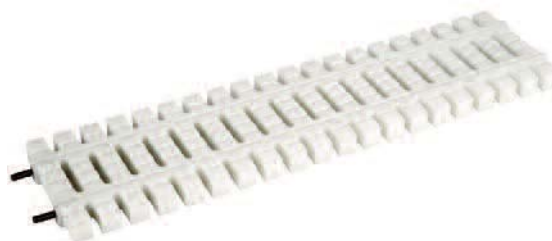

Composite (black and white)

Load class C250
 Recess for optional grating locking provided

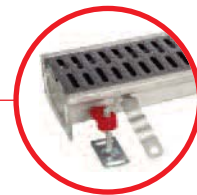

Note:

All grating designs load tested and certified to BS EN 1433. Declaration of Conformity available on request.
 Gratings supplied as standard without locking. Details of grating locking kits available are described on page 34.
 Please refer to page 33 for PVC Infill requirement for applications at Load Class B125.

Load Class and Wheel Loads

The ACO Modular 125⁺ stainless steel channel drainage system conforms to appropriate European standards in order to provide specifiers and installers with the confidence that products will achieve a known reliable performance.

The ACO Modular 125⁺ channel drainage system has been tested in accordance with BS EN 1433¹ and complimentary gully systems to BS EN 1253².

The table below indicates a practical approximate comparison of Load Classes to aid specifiers select products appropriate to an application.



Application	BS EN 1433 (Drainage Channels) and BS EN 124 (Manhole and Gully Tops)	BS EN 1253 (Gullies for Buildings) EN1253	FACTA	Slow Moving Wheel Load (Tonnes)	
				Pneumatic Tyres	Solid Tyres
	-	H1.5	-	Non-load bearing	
	A15	K3	A	0.5	N/A
		L15	AA	1.5	N/A
	B125	R50	AAA	2.5	0.5
		M125	B	5.0	0.75
	C250	N250	C	6.5	1.0
	D400	P400	D	11.0	3.0
	E600		E	16.0	5.0

Standards references:

¹BS EN 1433 - Drainage channels for vehicular and pedestrian areas.

²BS EN 1253 – Gullies for buildings.

Other useful references:

BS EN 124 - Gully tops and manhole tops for vehicular and pedestrian areas.

FACTA specification via <http://www.facta.org.uk/specification.pdf>

Specification and Product Selection

ACO Modular 125⁺ - Standard Products



The steps below guide customers through ACO Modular 125⁺ product selection and specification ensuring that all application considerations and aspects of the channel drainage system are covered. The ACO Building Drainage team can also provide a take-off (bill of materials) and estimating service based on your plan details.

ACO Modular 125⁺ - Customised Products



Occasionally it is necessary to shorten a channel and grating, or provide an outlet or inlet beyond those positions available in our standard product range. All of these modifications are easily accommodated within the ACO Modular 125⁺ product range and our manufacturing facilities. The ACO Building Drainage team can provide technical assistance and an estimating service based on your plan details using customised product.

Step 1 - Load consideration

Description	Helpful Hints	General Considerations	Page
<ul style="list-style-type: none"> Determine appropriate Load Class to BS EN 1433 for the application. 	<ul style="list-style-type: none"> Always allow for the highest loading and consider future use where possible. For industrial applications where pallet trucks and fork lift trucks may access the system, assess vehicle wheel loads as these can vary depending on the vehicle. 	<ul style="list-style-type: none"> Vehicles with solid tyres impart greater stress on gratings compared to pneumatic tyres. Do not use slip resistant mesh or ladder gratings in vehicle turning areas. 	14

Step 2 - Outline plan

Description	Helpful Hints	General Considerations	Page
<ul style="list-style-type: none"> Produce a plan of the proposed installation, identifying outlet points and invert depths at outlet points. 	<ul style="list-style-type: none"> ACO Building Drainage offers a free hydraulic calculation service which can optimise channel depths for a given capacity requirement. Contact the ACO Building Drainage Design Services Team on 01462 810431 or email abdtechnical@aco.co.uk for further details. 	<ul style="list-style-type: none"> Built-in fall (sloping invert) channels provide a degree of self-cleansing and should be used where possible. However, level invert or flat channels can function hydraulically where construction depth is restricted. 	8-9

Specification and Product Selection

Step 3 - Selecting an outlet

Description	Helpful Hints	General Considerations	Page
<ul style="list-style-type: none"> Select an outlet with an appropriate flow rate which meets any invert restrictions. 	<ul style="list-style-type: none"> Outlets will be at the lowest part of the system therefore select the deepest possible invert to allow for falls within the channels connected to it. Horizontal outlets offer shallower outlet points but are not as efficient hydraulically. 	<ul style="list-style-type: none"> Consider both maintenance facilities and aesthetics. 	18-29

Outlet option 1 - Spigot outlet

Description	Maintenance	Aesthetics	Page
<ul style="list-style-type: none"> Ø110mm spigot outlets can be supplied with or without a foul air trap. If no foul air trap is used a sediment basket can be installed. If a foul air trap is used a sieve can be fitted. 	<ul style="list-style-type: none"> Sediment baskets and sieves require periodic removal and cleaning. Complete cleaning will require removal of the foul air trap. Note: Jetting or rodding is achieved via the removal of the foul air trap. 	<ul style="list-style-type: none"> Spigot outlets are not visually intrusive and can be located by visual inspection along a channel run. 	18-20

Outlet option 2 - Discreet channel gully

Description	Maintenance	Aesthetics	Page
<ul style="list-style-type: none"> Ø142mm discreet channel gully provides greater flow rates than spigot outlets. Flow rate is optimised in the 125mm deep gully. 	<ul style="list-style-type: none"> Sediment baskets and sieves require periodic removal and cleaning. Complete cleaning will require removal of the foul air trap. Note: Jetting or rodding is achieved via the removal of the foul air trap. 	<ul style="list-style-type: none"> Discreet channel gullies are not visually intrusive and can be located by visual inspection along a channel run. 	21-24

Outlet option 3 - Gully outlet

Description	Maintenance	Aesthetics	Page
<ul style="list-style-type: none"> One or two-way gully outlet options with a Ø200mm outlet provide greater hydraulic capacity than discreet channel gullies. Hydraulic capacity is maximised in vertical orientation. 	<ul style="list-style-type: none"> Silt baskets and sieves require periodic removal and cleaning. Complete cleaning will require removal of the foul air trap. Note: Jetting or rodding is achieved via the removal of the foul air trap. Gully bodies have rounded bowls to minimise silt build up. 	<ul style="list-style-type: none"> The gully top is wider than the channel and is therefore identifiable within a channel run. Gully top grating options do not include standard Slotted, Plastic, Composite, Quadrato or Slotted Intercept grating styles which are available in the ACO Modular 125⁺ grating range. 	25-29

Specification and Product Selection

Step 4 - Adding channels

Description	Helpful Hints	General Considerations	Page
<ul style="list-style-type: none"> Start at the outlet position and work back adding channels as appropriate. Where combined falls or sloping falls are required, ensure there is a logical fall to the outlet where the deepest channel sections are positioned. 	<ul style="list-style-type: none"> ACO Modular 125⁺ corners and branch units are level inverts and therefore consideration is required when planning channel layouts. Using longer length channels saves cost, minimises joints and reduces installation time. Shortening built-in fall channels is possible only at the start of a run. To adjust a built-in fall mid-run, it is necessary to introduce a level invert channel. 	<ul style="list-style-type: none"> Hydraulic flow can be effected by introducing level invert sections within a sloping channel run. 	30-32

Step 5 - Adding end plates

Description	Helpful Hints	General Considerations	Page
<ul style="list-style-type: none"> Terminate the drainage system with end plates corresponding to the channel invert at ends. 	N/A	<ul style="list-style-type: none"> The addition of each end plate will increase length of channel run by 14mm. 	33

Step 6 - Channel edge options

Description	Helpful Hints	General Considerations	Page
<ul style="list-style-type: none"> Select channel edge detail appropriate for the Load Class and flooring finish. 	<ul style="list-style-type: none"> PVC infill is a low cost option for improving overall channel durability in trafficked areas. ACO Vinyl Seal® is not suitable for wooden or suspended floors. 	<ul style="list-style-type: none"> For Load Class B125, PVC infill will be supplied as standard. Vinyl / flexible sheet flooring can be seamlessly welded to ACO Vinyl Seal®. 	33-34

Step 7 - Select gratings

Description	Helpful Hints	General Considerations	Page
<ul style="list-style-type: none"> Confirm correct Load Class for the application and select appropriate gratings style from the ACO Modular 125⁺ grating range. 	<ul style="list-style-type: none"> Security lockings can be specified to all gratings at extra cost. Do not use slip resistant gratings where vehicles are likely to turn on the grate. 	<ul style="list-style-type: none"> For bare foot areas consider Heelsafe, Quadrato, Intercept or Plastic grating styles. Consider grating availability for both channel and gully. 	35-40

Spigot Outlets

500mm End Spigot Outlets

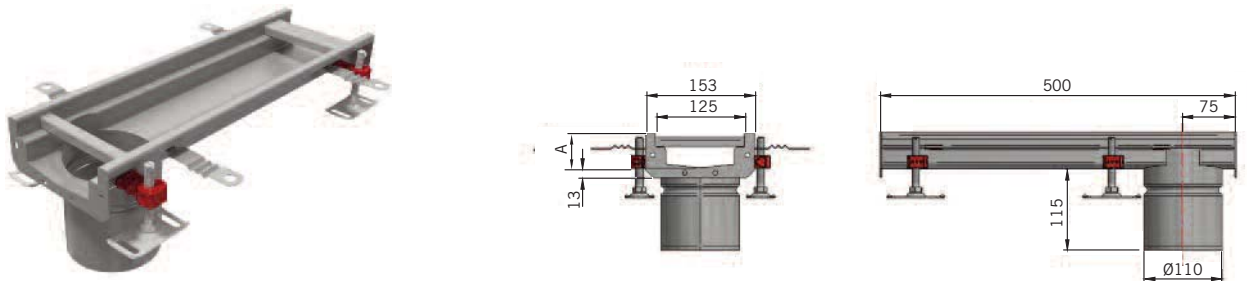

Part No	Description	A (mm)	Flow Rate* (l/s)	Weight (kg)
105175	500mm End Spigot Outlet	50	1.2	2.6
105176		65	1.2	2.8
105177		80	1.2	3.1
105178		95	1.2	3.3
105179		110	1.2	3.5
105180		125	1.2	3.7

*Assumes use of 110 outlet foul air trap, part number 97217 (see page 20)

1000mm End Spigot Outlets

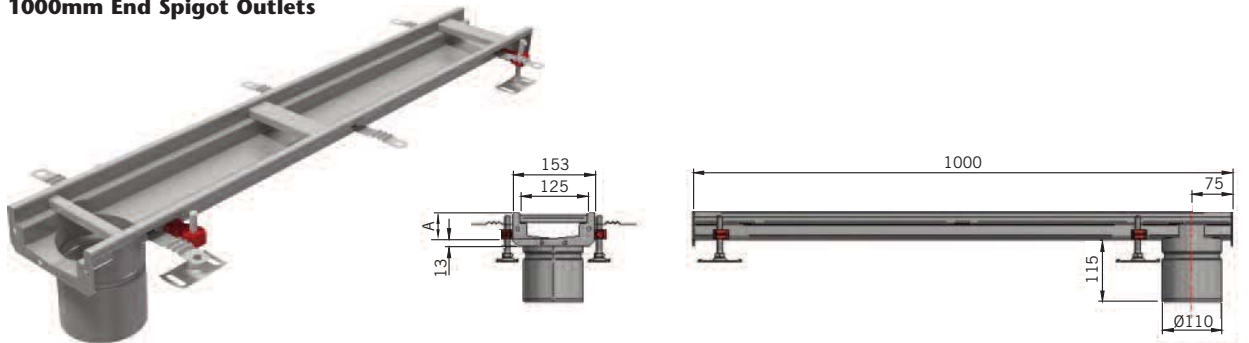

Part No	Description	A (mm)	Flow Rate* (l/s)	Weight (kg)
105183	1000mm End Spigot Outlet	50	1.2	4.2
105184		65	1.2	4.6
105185		80	1.2	5.0
105186		95	1.2	5.4
105187		110	1.2	5.8
105188		125	1.2	6.2

*Assumes use of 110 outlet foul air trap, part number 97217 (see page 20)

Note:

For applications requiring 316 stainless steel channel drainage please contact the ACO Building Drainage Team on **01462 810421** or e-mail abdestimating@aco.co.uk for further details.

Spigot Outlets

500mm Centre Spigot Outlets

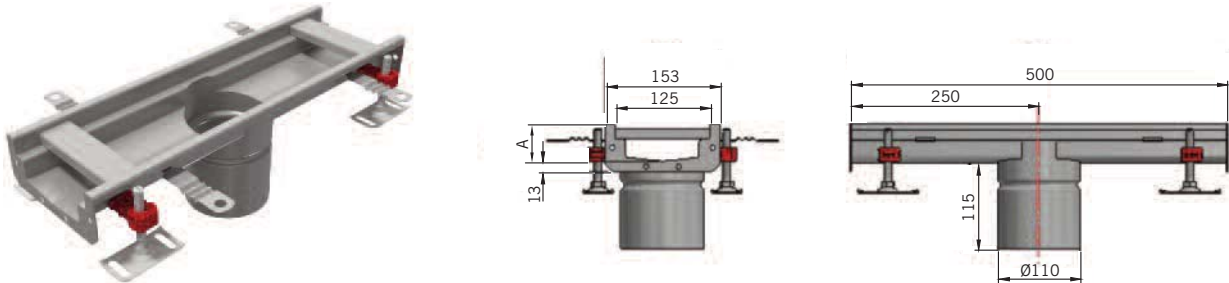

Part No	Description	A (mm)	Flow Rate* (l/s)	Weight (kg)
105191	500mm Centre Spigot Outlet	50	1.2	2.7
105192		65	1.2	2.9
105193		80	1.2	3.1
105194		95	1.2	3.3
105195		110	1.2	3.5
105196		125	1.2	3.7

*Assumes use of 110 outlet foul air trap, part number 97217 (see page 20)

1000mm Centre Spigot Outlets

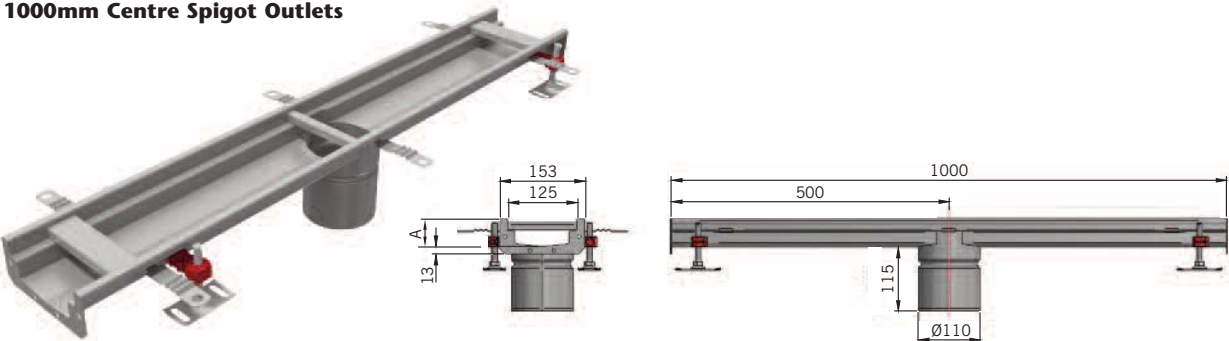

Part No	Description	A (mm)	Flow Rate* (l/s)	Weight (kg)
105199	1000mm Centre Spigot Outlet	50	1.2	4.2
105200		65	1.2	4.6
105201		80	1.2	5.1
105202		95	1.2	5.4
105203		110	1.2	5.8
105204		125	1.2	6.2

*Assumes use of 110 outlet foul air trap, part number 97217 (see page 20)

Note:

For applications requiring 316 stainless steel channel drainage please contact the ACO Building Drainage Team on **01462 810421** or e-mail abdestimating@aco.co.uk for further details.

Spigot Outlet Accessories

Sediment Basket

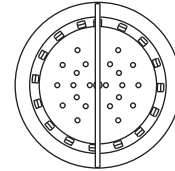
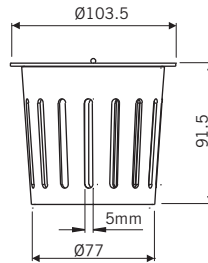

Part No	Description	Weight (kg)
21510	Sediment Basket S/S 304	0.1

Sieve

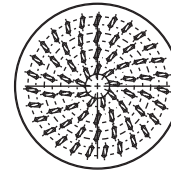
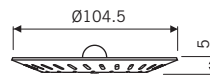

Part No	Description	Weight (kg)
97235	Sieve S/S 304	0.1

Ø110mm Outlet Foul Air Trap

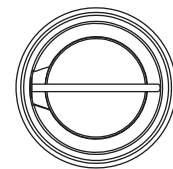
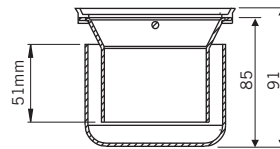
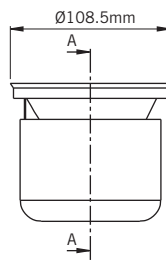

Part No	Description	Flow Rate (l/s)	Weight (kg)
97217	110mm Outlet Foul Air Trap S/S 304	1.2	0.3

Note:

For applications requiring 316 stainless steel channel drainage please contact the ACO Building Drainage Team on **01462 810421** or e-mail abdestimating@aco.co.uk for further details.

Discreet Channel Gullies

500mm Discreet Channel Gully

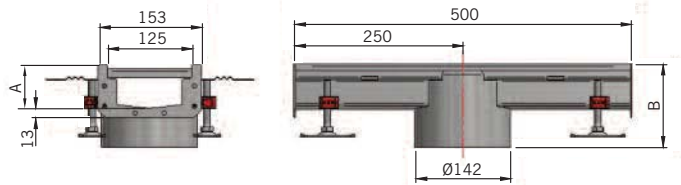
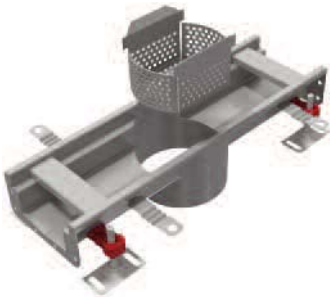

Part No	Description	A (mm)	B (mm)	Flow Rate* (l/s)	Weight (kg)
105381	Discreet Channel Gully S/S 304	65	120	2.8 - 4.5	3.1
105382		95	150	2.8 - 4.5	3.5
105383		125	180	2.8 - 4.5	4.0
105384	Sediment Basket 0.55 litre capacity S/S 304	N/A	N/A	-	0.1

*Flow rate dependant on horizontal or vertical outlet gully body selection.

Discreet Channel Gully Assembly Inverts

Discreet Channel Gully with Vertical Gully Outlet

	H = 65mm	H = 95mm	H = 125mm
A Min	70	100	130
A Max	115	145	175
B Min	339	369	399
B Max	384	414	444

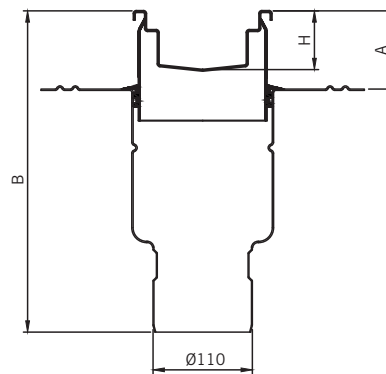

One Way and Two Way Gully Tops with Horizontal Gully Outlet

	H = 65mm	H = 95mm	H = 125mm
A Min	90	120	150
A Max	115	145	175
C Min	243	273	303
C Max	268	298	328

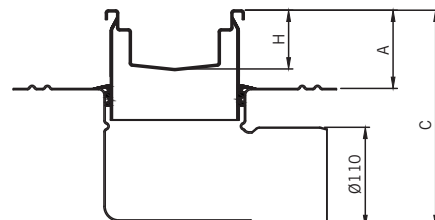

Note:

The Discreet Channel Gully requires the selection of appropriate gully body as shown on pages 22-23.

For applications requiring 316 stainless steel channel drainage please contact the ACO Building Drainage Team on **01462 810421**

or e-mail abdestimating@aco.co.uk for further details.

ACO Gully 157 for use with Discreet Channel Gully

ACO Gully 157 - Telescopic

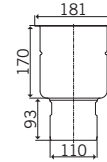

Part No	Description	Flange Type	Outlet Size	Flow Rate* (l/s)	Weight (kg)
408055	Telescopic – vertical outlet S/S 304	Location flange	Ø110mm	3.9 - 4.2 l/s	2.3

*Flow rate will depend on telescopic height configuration when installed.

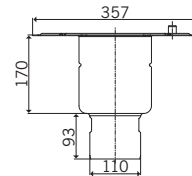

Part No	Description	Flange Type	Outlet Size	Flow Rate* (l/s)	Weight (kg)
408057	Telescopic – vertical outlet S/S 304	Adhesive bonding flange	Ø110mm	3.9 - 4.2 l/s	3.3

*Flow rate will depend on telescopic height configuration when installed.

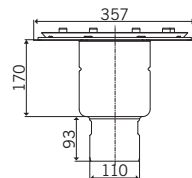

Part No	Description	Flange Type	Outlet Size	Flow Rate* (l/s)	Weight (kg)
408059	Telescopic – vertical outlet S/S 304	Mechanical clamping flange	Ø110mm	3.9 - 4.2 l/s	4.3

*Flow rate will depend on telescopic height configuration when installed.

Note:

For assembled Discreet Channel Gully and gully body heights, refer to page 21.

ACO Gully 157 available in 316 Stainless Steel. Please refer to ACO Stainless Steel Gully Systems product catalogue or contact the ACO Building Drainage Team on **01462 810421** or e-mail **abdestimating@aco.co.uk** for further details.

ACO Gully 157 for use with Discreet Channel Gully

ACO Gully 157 - Telescopic

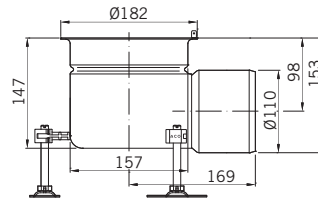

Part No	Description	Flange Type	Outlet Size	Flow Rate* (l/s)	Weight (kg)
408079	Telescopic – horizontal outlet S/S 304	Location flange	Ø110mm	3.2 - 3.9 l/s	2.2

*Flow rate will depend on telescopic height configuration when installed.

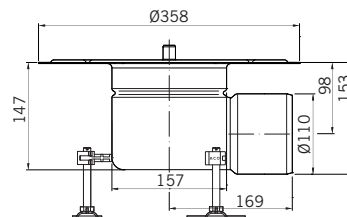

Part No	Description	Flange Type	Outlet Size	Flow Rate* (l/s)	Weight (kg)
408081	Telescopic – horizontal outlet S/S 304	Adhesive bonding flange	Ø110mm	3.2 - 3.9 l/s	3.2

*Flow rate will depend on telescopic height configuration when installed.

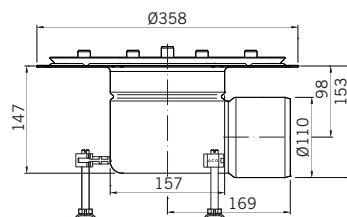

Part No	Description	Flange Type	Outlet Size	Flow Rate* (l/s)	Weight (kg)
408083	Telescopic – horizontal outlet S/S 304	Mechanical clamping flange	Ø110mm	3.2 - 3.9 l/s	4.1

*Flow rate will depend on telescopic height configuration when installed.



All products listed on pages 22 & 23 come complete with Foul Air Trap (see pages 18-20 for replacements).

Note:

For assembled Discreet Channel Gully and gully body heights, refer to page 21.

ACO Gully 157 available in 316 Stainless Steel. Please refer to ACO Stainless Steel Gully Systems product catalogue or contact the ACO Building Drainage Team on **01462 810421** or e-mail **abdestimating@aco.co.uk** for further details.

ACO Gully 157 Accessories / Replacements

Foul Air Trap

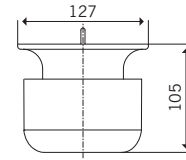

Part No	Description	Weight (kg)
408200	Foul Air Trap S/S 304 (replacement)	0.8

Foul Air Trap Support Ring

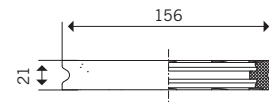

Part No	Description	Weight (kg)
408201	Foul Air Trap Support Ring Nitrile (replacement)	0.1

Friction Ring Installation Set

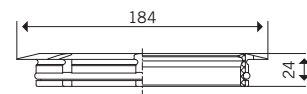

Part No	Description	Weight (kg)
408205	Friction Ring Installation Set (replacement)	0.07

Gully Outlets

One Way Gully Top

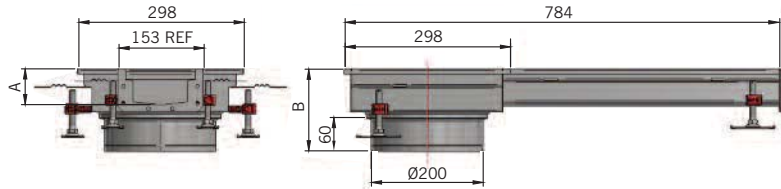
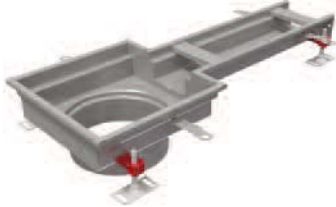

Part No	Description	A (mm)	B (mm)	Weight (kg)
105375	One Way Gully Top S/S 304	65	145	4.6
105376		95	175	5.2
105377		125	205	6.2

Two Way Gully Top

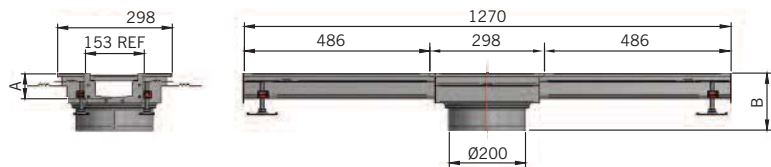

Part No	Description	A (mm)	B (mm)	Weight (kg)
105378	Two Way Gully Top S/S 304	65	145	4.6
105379		95	175	5.2
105380		125	205	6.2

Gully Outlet Assembly Inverts

One Way and Two Way Gully Tops with Vertical Gully Outlet

	H = 65mm	H = 95mm	H = 125mm
A Min	96	126	156
A Max	124	154	184
B Min	366	396	426
B Max	394	424	454

One Way and Two Way Gully Tops with Horizontal Gully Outlet

	H = 65mm	H = 95mm	H = 125mm
A Min	96	126	156
A Max	124	154	184
C Min	244	274	304
C Max	272	302	332
D Min	221	251	281
D Max	249	279	309

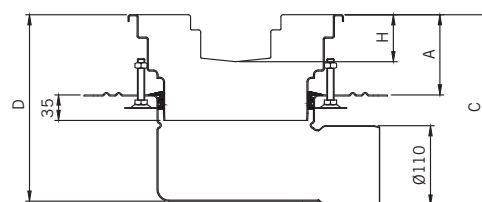
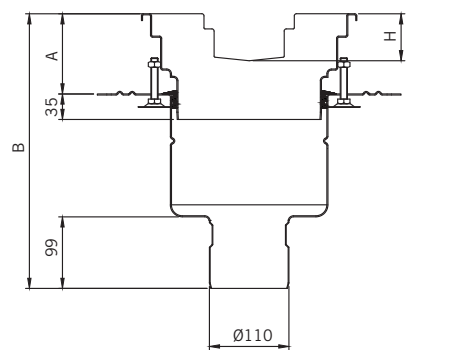

Note:

The One Way and Two Way Gully Tops require the selection of appropriate gully body as shown on pages 26-28. For applications requiring 316 stainless steel channel drainage please contact the ACO Building Drainage Team on 01462 810421 or e-mail abdestimating@aco.co.uk for further details.

ACO Gully 218 for use with One Way and Two Way Gully Tops

ACO Gully 218 - Telescopic

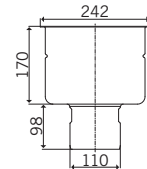

Part No	Description	Flange Type	Outlet Size	Flow Rate* (l/s)	Weight (kg)
408061	Telescopic – vertical outlet S/S 304	Location flange	Ø110mm	5.0 - 6.3 l/s	3.2

*Flow rate will depend on telescopic height configuration when installed.

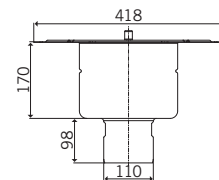

Part No	Description	Flange Type	Outlet Size	Flow Rate* (l/s)	Weight (kg)
408063	Telescopic – vertical outlet S/S 304	Adhesive bonding flange	Ø110mm	5.0 - 6.3 l/s	4.4

*Flow rate will depend on telescopic height configuration when installed.

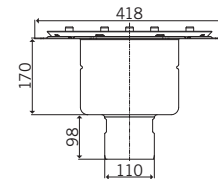

Part No	Description	Flange Type	Outlet Size	Flow Rate* (l/s)	Weight (kg)
408065	Telescopic – vertical outlet S/S 304	Mechanical clamping flange	Ø110mm	5.0 - 6.3 l/s	5.5

*Flow rate will depend on telescopic height configuration when installed.

Note:

For assembled gully outlet and gully body heights, refer to page 25.

ACO Gully 218 available in 316 Stainless Steel. Please refer to ACO Stainless Steel Gully Systems product catalogue or contact the ACO Building Drainage Team on **01462 810421** or e-mail **abdestimating@aco.co.uk** for further details.

ACO Gully 218 for use with One Way and Two Way Gully Tops

ACO Gully 218 - Telescopic

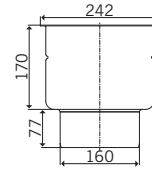

Part No	Description	Flange Type	Outlet Size	Flow Rate* (l/s)	Weight (kg)
408067	Telescopic – vertical outlet S/S 304	Location flange	Ø160mm	5.0 - 6.3 l/s	3.2

*Flow rate will depend on telescopic height configuration when installed.

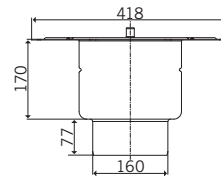

Part No	Description	Flange Type	Outlet Size	Flow Rate* (l/s)	Weight (kg)
408069	Telescopic – vertical outlet S/S 304	Adhesive bonding flange	Ø160mm	5.0 - 6.3 l/s	4.4

*Flow rate will depend on telescopic height configuration when installed.

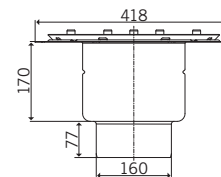

Part No	Description	Flange Type	Outlet Size	Flow Rate* (l/s)	Weight (kg)
408071	Telescopic – vertical outlet S/S 304	Mechanical clamping flange	Ø160mm	5.0 - 6.3 l/s	5.5

*Flow rate will depend on telescopic height configuration when installed.

Note:

For assembled gully outlet and gully body heights, refer to page 25.

ACO Gully 218 available in 316 Stainless Steel. Please refer to ACO Stainless Steel Gully Systems product catalogue or contact the ACO Building Drainage Team on **01462 810421** or e-mail **abdestimating@aco.co.uk** for further details.

ACO Gully 218 for use with One Way and Two Way Gully Tops

ACO Gully 218 - Telescopic

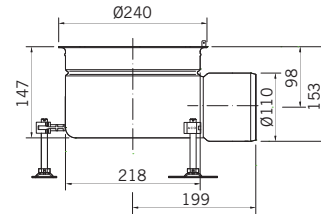

Part No	Description	Flange Type	Outlet Size	Flow Rate* (l/s)	Weight (kg)
408085	Telescopic – horizontal outlet S/S 304	Location flange	Ø110mm	4.4 - 5.5 l/s	2.2

*Flow rate will depend on telescopic height configuration when installed.

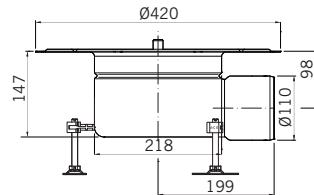

Part No	Description	Flange Type	Outlet Size	Flow Rate* (l/s)	Weight (kg)
408087	Telescopic – horizontal outlet S/S 304	Adhesive bonding flange	Ø110mm	4.4 - 5.5 l/s	4.2

*Flow rate will depend on telescopic height configuration when installed.

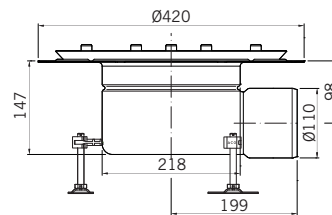

Part No	Description	Flange Type	Outlet Size	Flow Rate* (l/s)	Weight (kg)
408089	Telescopic – horizontal outlet S/S 304	Mechanical clamping flange	Ø110mm	4.4 - 5.5 l/s	4.4

*Flow rate will depend on telescopic height configuration when installed.



All products listed on pages 26-28 come complete with Foul Air Trap (see page 29 for replacements).

Note:

For assembled gully outlet and gully body heights, refer to page 25.

ACO Gully 218 available in 316 Stainless Steel. Please refer to ACO Stainless Steel Gully Systems product catalogue or contact the ACO Building Drainage Team on **01462 810421** or e-mail abdestimating@aco.co.uk for further details.

ACO Gully 218 Accessories / Replacements

Silt Basket



Part No	Description	Weight (kg)
408222	Vertical Outlet Gully Silt Basket 1.4 litre capacity S/S 304	0.7
408223	Horizontal Outlet Gully Silt Basket 0.7 litre capacity S/S 304	0.6

Foul Air Trap



Part No	Description	Weight (kg)
408220	Foul Air Trap S/S 304 (replacement)	1.2

Foul Air Trap Support Ring



Part No	Description	Weight (kg)
408221	Foul Air Trap Support Ring Nitrile (replacement)	1.2

Friction Ring Installation Set



Part No	Description	Weight (kg)
408225	Friction Ring Installation Set (replacement)	0.09

Level Invert Channels

Level Invert Channels

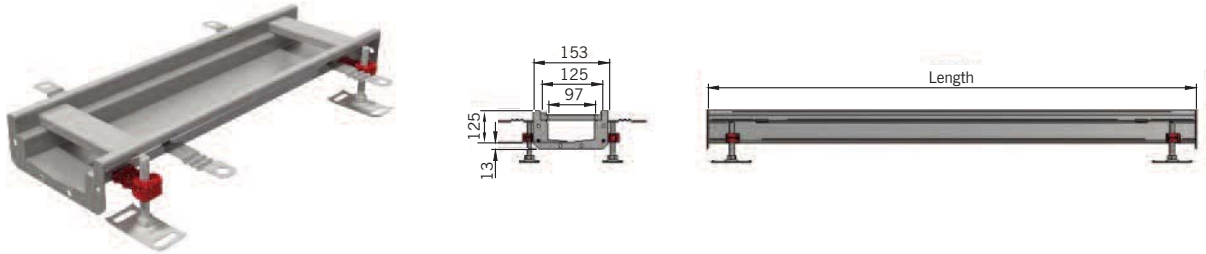

Part No	Description	L (mm)	A (mm)	Weight (kg)
105119	Level Invert Channel S/S 304	500	50	2.3
105120			65	2.5
105121			80	2.7
105122			95	2.9
105123			110	3.1
105124			125	3.4
105127		1000	50	3.9
105128			65	4.2
105129			80	4.6
105130			95	5.0
105131			110	5.4
105132		125	5.8	
105135		2000	50	3.9
105136			65	4.2
105137			80	4.6
105138			95	5.0
105139			110	5.4
105140			125	5.8
105143		3000	50	10.2
105144			65	11.3
105145			80	12.4
105146			95	13.5
105147			110	14.6
105148		125	15.7	

Note:

All channels are supplied complete with levelling feet, fixing ties, neoprene gaskets and fixings.

For applications requiring 316 stainless steel channel drainage please contact the ACO Building Drainage Team on **01462 810421** or e-mail abdestimating@aco.co.uk for further details.

Sloping Invert Channels

Sloping Invert Channels

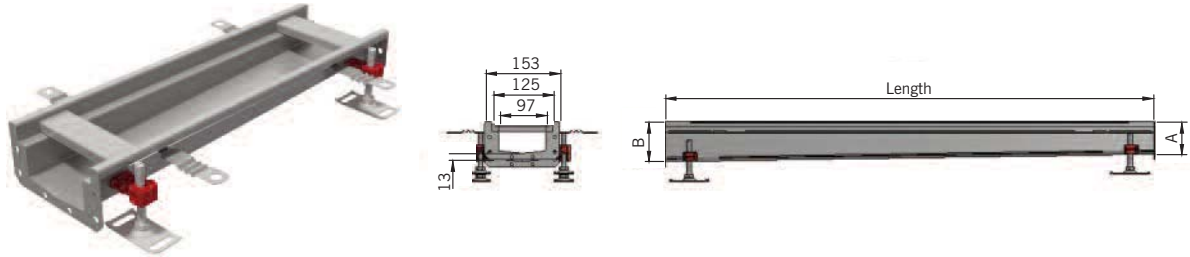

Part No	Description	L (mm)	A (mm)	B (mm)	Weight (kg)
105151	Sloping Invert Channel S/S 304	500	50	65	2.4
105152			65	80	2.5
105155		1000	50	65	4.0
105156			65	80	4.4
105157			80	95	4.8
105158		95	110	5.2	
105161		2000	50	65	7.5
105162			65	80	8.2
105163			80	95	8.9
105164			95	110	9.7
105165			110	125	10.5
105168		3000	50	65	10.7
105169			65	80	11.8
105170			80	95	12.9
105171			95	110	14.0
105172			110	125	15.1

Note:

All channels are supplied complete with levelling feet, fixing ties, neoprene gaskets and fixings.

For applications requiring 316 stainless steel channel drainage please contact the ACO Building Drainage Team on **01462 810421** or e-mail abdestimating@aco.co.uk for further details.

Corner and Branch Units

Corner Unit – Right Hand

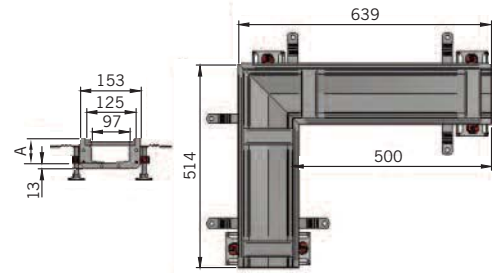
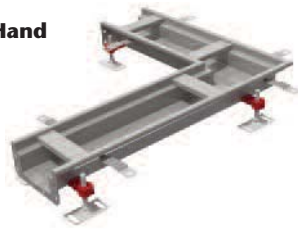

Part No	Description	L (mm)	A (mm)	Weight (kg)
105207	Corner Unit Right Hand S/S 304	500	50	3.9
105208			65	4.3
105209			80	4.7
105210			95	5.1
105211			110	5.5
105212			125	5.8

Corner Unit – Left Hand

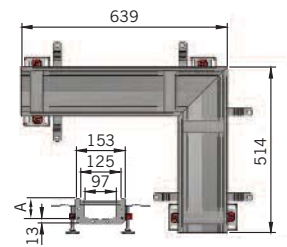
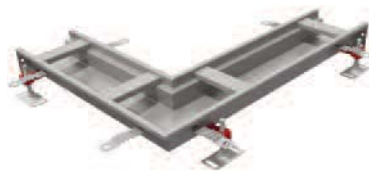

Part No	Description	L (mm)	A (mm)	Weight (kg)
105214	Corner Unit Left Hand S/S 304	500	50	3.9
105215			65	4.3
105216			80	4.7
105217			95	5.1
105218			110	5.4
105219			125	5.8

Branch Unit

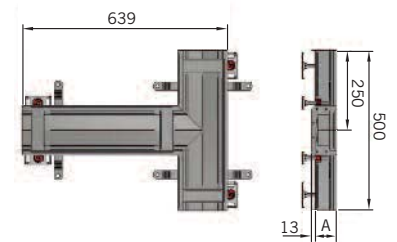
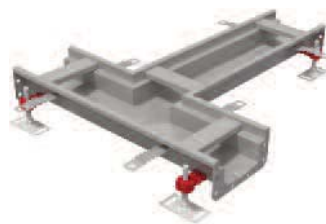

Part No	Description	L (mm)	A (mm)	Weight (kg)
105221	Branch Unit S/S 304	500	50	4.0
105222			65	4.3
105223			80	4.8
105224			95	5.1
105225			110	5.5
105226			125	6.3

Note:

All channels are supplied complete with levelling feet, fixing ties, neoprene gaskets and fixings.

For applications requiring 316 stainless steel channel drainage please contact the ACO Building Drainage Team on **01462 810421**

or e-mail abdestimating@aco.co.uk for further details.

End Plates and PVC Infill

End Plates

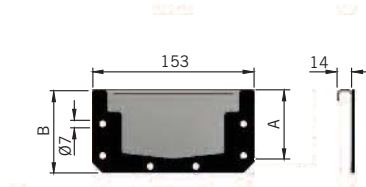

Part No	Description	A (mm)	B (mm)	Weight (kg)
105100	End Plates S/S 304*	50	63	0.14
105101		65	78	0.17
105102		80	93	0.21
105103		95	108	0.22
105104		110	123	0.25
105105		125	138	0.28

*All end plates are supplied complete with neoprene gaskets and fixings.

PVC Infill

PVC Infill can be inserted into the underside of the visible edge of channels and associated component sections to provide additional strength and prevent damage to the visible edge of channels and components PVC Infill is recommended for installations that are subject to wheeled heavy loadings from trolleys or vehicles. **This must be included for applications at Load Class B125 and above.**

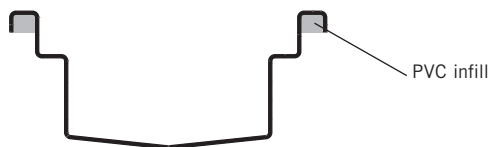

Part No	Description	Unit*	Weight (kg) per metre
45107	PVC Infill	Per channel metre	0.5

*Double quantity required for each metre of channel (including ends).

Note:

PVC Infill supplied loose for installation on site.

For applications requiring 316 stainless steel channel drainage please contact the ACO Building Drainage Team on **01462 810421**

or e-mail abdestimating@aco.co.uk for further details.

ACO Vinyl Seal® and Grating Lockings and Security

ACO Vinyl Seal®

Ideal for vinyl/flexible sheet flooring applications, ACO Vinyl Seal® can be used to create a fully welded system that is watertight and improves hygiene performance by eliminating cumbersome mechanical clamping systems. ACO Vinyl Seal® is not suitable for wooden or suspended floors.

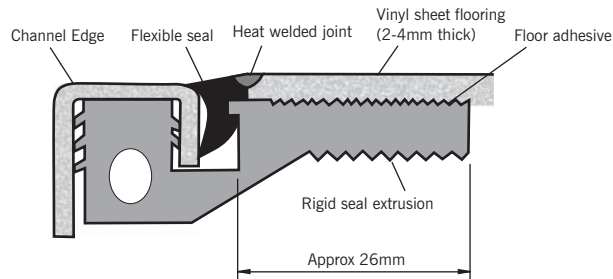

Part No	Description	Unit*	Weight (kg)
49062	Flexible PVC Seal	*Per channel metre	0.01
49061	Rigid PVC Extrusion	*Per channel metre	0.1
49063	10" Sheet Plier Grip Wrench	Each	0.5

*Double quantity required for each metre of channel (including ends).

Grating Lockings and Security

For applications where locked gratings are required, the ACO Modular 125⁺ channel system can be supplied with factory fitted standard lockings (activated by a standard hexagon wrench) or security locking (activated by a security wrench).

Note:

- Channel systems required with locking accessory require appropriate grating recess.
If locking recess is not standard then grating locking modification will be required.
- Gully gratings will be modified at the factory for locking as part of gully locking kit.
- Locking kits include channel gully modification locking bar and fixing.
- Appropriate standard or security locking wrench to be ordered separately, as per options above.

Part No	Description	Unit
26310	Standard Channel Locking Kit	Per metre channel run
26320	Security Channel Locking Kit	Per metre channel run
26340	Grating Locking Modification	Per metre (not required for gratings with locking access as standard)
26360	Standard Gully Locking Kit	Per gully top
26350	Security Gully Locking Kit	Per gully top
46876	Standard Hexagon Locking Wrench 5mm	-
46786	Security Hexagon Locking Wrench 5mm	-

Note:

For applications requiring 316 stainless steel channel drainage please contact the ACO Building Drainage Team on **01462 810421** or e-mail abdestimating@aco.co.uk for further details.

Channel Gratings – Stainless steel for general use

Plain Mesh

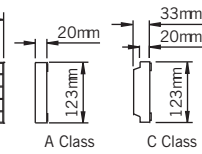
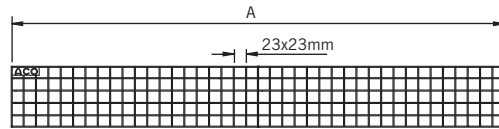
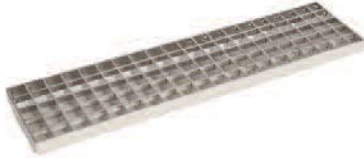

Part No	Description	A (mm)	BS EN 1433 Load Class	Finish	Weight (kg)
21620	Plain Mesh S/S 304*	1000	A15	Electropolished	3.0
21720		500	A15	Electropolished	1.6
21820		1000	C250†	Electropolished	4.2
21920		500	C250†	Electropolished	2.2

Slip Resistant Mesh

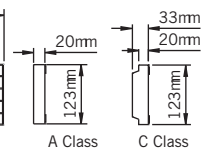
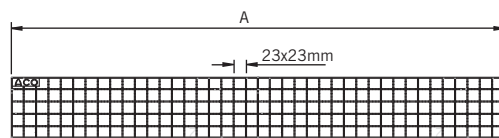

Part No	Description	A (mm)	BS EN 1433 Load Class	Finish	Weight (kg)
21610	Slip Resistant Mesh S/S 304*	1000	A15	Electropolished	3.0
21710		500	A15	Electropolished	1.6
21810		1000	C250†	Electropolished	4.2
21910		500	C250†	Electropolished	2.2

Heelsafe

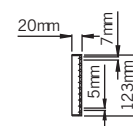
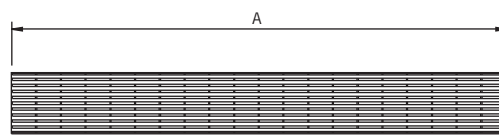

Part No	Description	A (mm)	BS EN 1433 Load Class	Finish	Weight (kg)
96818	Heelsafe S/S 304	1000	B125	Linished	3.4
96819		500	B125	Linished	2.0

Note:

*Locking recess available on request.

†Please refer to page 33 for PVC Infill required for applications at Load Class B125 and higher.

**Please refer to page 7 for explanation of symbols.

For applications requiring 316 stainless steel channel drainage please contact the ACO Building Drainage Team on **01462 810421**

or e-mail abdestimating@aco.co.uk for further details.

Channel Gratings – Stainless steel for general use

Heelsafe Locked*

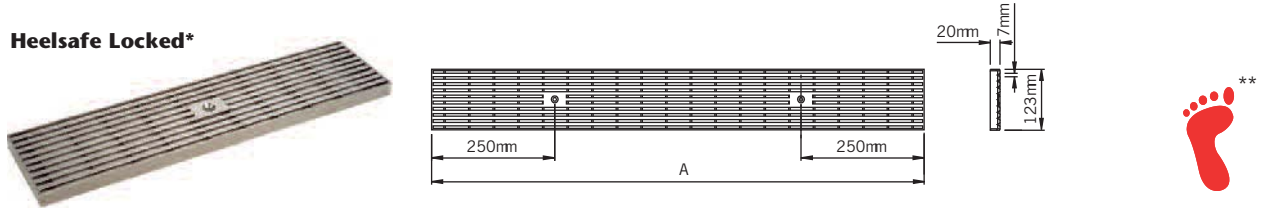

Part No	Description	A (mm)	BS EN 1433 Load Class	Finish	Weight (kg)
402071	Heelsafe Locked S/S 304*	1000	B125†	Linished	3.4
402072		500	B125†	Linished	2.0

Ladder

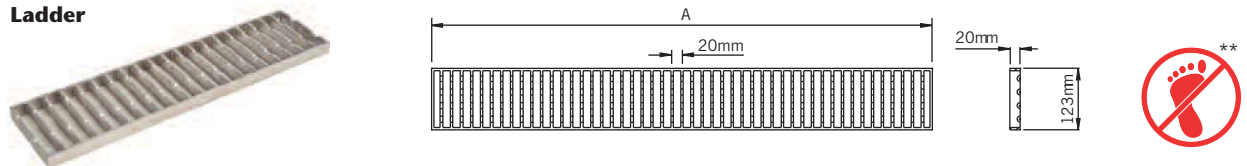

Part No	Description	A (mm)	BS EN 1433 Load Class	Finish	Weight (kg)
21741	Ladder S/S 304 (Reversible Plain or Slip Resistant)	1000	C250†	Pickled	3.4
21740		500	C250†	Pickled	2.0

Quadrato

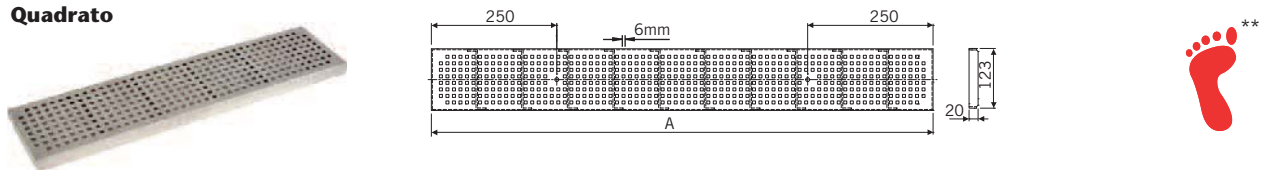

Part No	Description	A (mm)	BS EN 1433 Load Class	Finish	Weight (kg)
105529	Quadrato S/S 304	1000	A15	Linished	3.2
105530		500	A15	Linished	1.6
105527	Quadrato Locked S/S 304*	1000	A15	Linished	3.2
105528		500	A15	Linished	1.6
105841	Slip Resistant Quadrato S/S 304	1000	A15	Linished	3.2
105842		500	A15	Linished	1.6
105843	Slip Resistant Quadrato Locked S/S 304*	1000	A15	Linished	3.2
105844		500	A15	Linished	1.6

Note:

*Locking recess in grating provided as standard. Refer to page 34 for channel locking kits and appropriate wrench to complete locked grating system.

†Please refer to page 33 for PVC Infill required for applications at Load Class B125 and higher.

**Please refer to page 7 for explanation of symbols.

For applications requiring 316 stainless steel channel drainage please contact the ACO Building Drainage Team on **01462 810421**

or e-mail abdestimating@aco.co.uk for further details.

Channel Gratings – Stainless steel for general use

Slotted Locked*

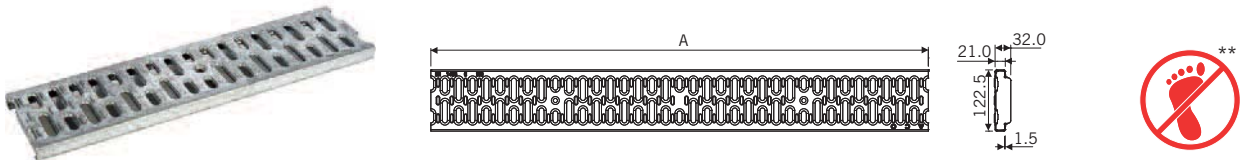

Part No	Description	A (mm)	BS EN 1433 Load Class	Finish	Weight (kg)
105518	Slotted Locked S/S 304*	1000	A15	Pickled	2.0
105519		500	A15	Pickled	1.0
105520		1000	C250†	Pickled	4.7
105521		500	C250†	Pickled	2.3

Perforated Locked*

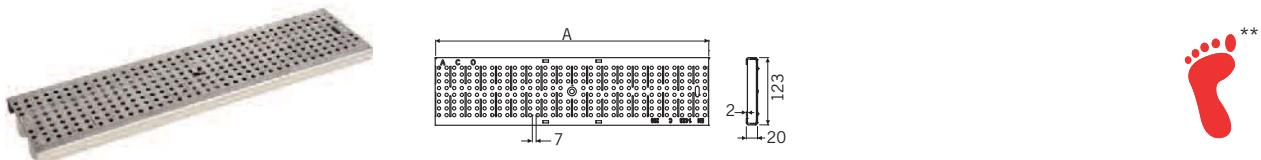

Part No	Description	A (mm)	BS EN 1433 Load Class	Finish	Weight (kg)
105504	Perforated Locked S/S 304*	1000	C250†	Pickled	3.6
105505		500	C250†	Pickled	1.8

Intercept

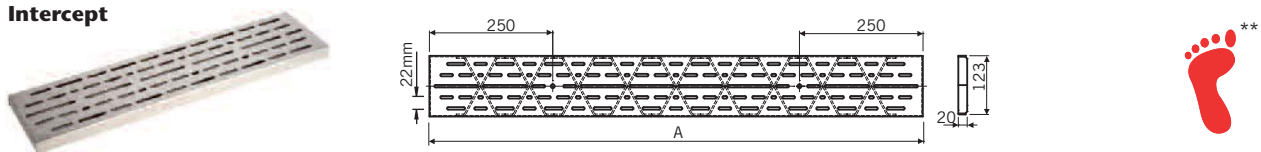

Part No	Description	A (mm)	BS EN 1433 Load Class	Finish	Weight (kg)
105538	Intercept S/S 304	1000	A15	Linished	3.6
105539		500	A15	Linished	1.8
105536	Intercept Locked S/S 304*	1000	A15	Linished	3.6
105537		500	A15	Linished	1.8
105845	Slip Resistant Intercept S/S 304	1000	A15	Linished	3.6
105846		500	A15	Linished	1.8
105847	Slip Resistant Intercept Locked S/S 304*	1000	A15	Linished	3.6
105848		500	A15	Linished	1.8

Note:

*Locking recess in grating provided as standard. Refer to page 34 for channel locking kits and appropriate wrench to complete locked grating system.

†Please refer to page 33 for PVC Infill required for applications at Load Class B125 and higher.

**Please refer to page 7 for explanation of symbols.

Channel Gratings – Stainless steel for external use only

Heelsafe External Locked*

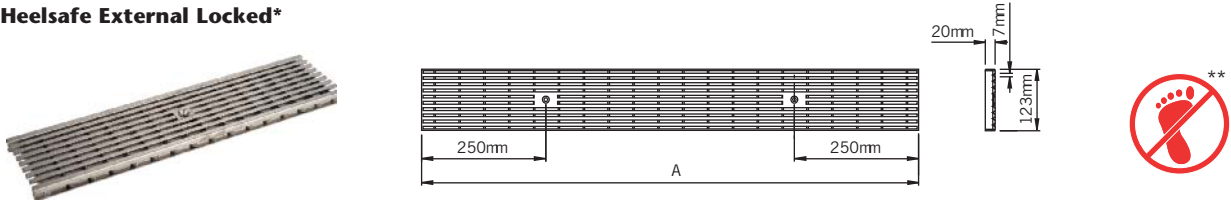

Part No	Description	A (mm)	BS EN 1433 Load Class	Finish	Weight (kg)
445486	Heelsafe Grating Ladder S/S 304	1000	B125†	Linished	3.7
445487		500	B125†	Linished	1.9

Channel Gratings – Plastic

Plastic

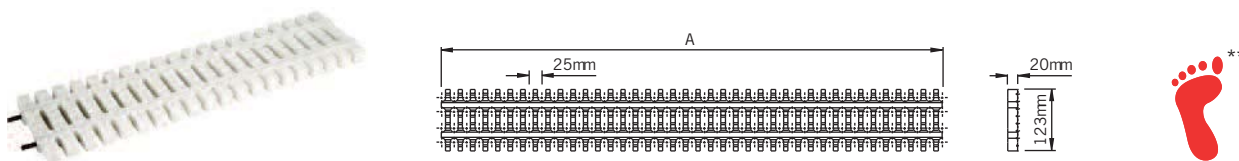

Part No	Description	A (mm)	BS EN 1433 Load Class	Finish	Weight (kg)
21690	White Plastic	1000	A15	White	1.2
21790		500	A15	White	0.6

Channel Gratings – Composite

Composite

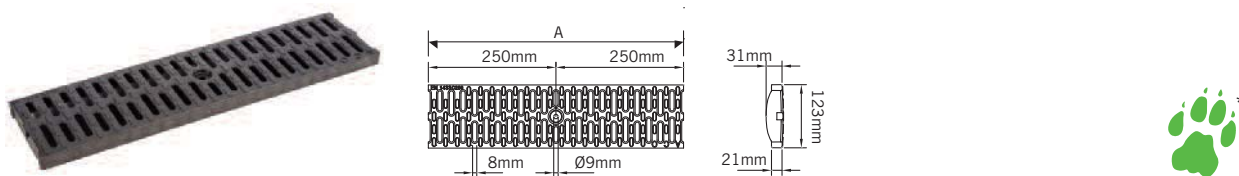

Part No	Description	A (mm)	BS EN 1433 Load Class	Finish	Weight (kg)
15704	Black Composite*	500	C250†	Black	1.2
10735	White Composite*	500	C250†	White	1.2

Note:

*Locking recess in grating provided as standard. Refer to page 34 for channel locking kits and appropriate wrench to complete locked grating system.

†Please refer to page 33 for PVC Infill required for applications at Load Class B125 and higher.

**Please refer to page 7 for explanation of symbols.

ACO Gully 218 Gratings for use with One and Two Way Gully Tops

Ladder

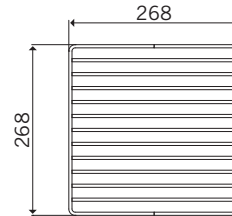

Part No	Description	Depth (mm)	Load Class	Finish	Weight (kg)
408045	Plain Ladder S/S 304	30	C250†	Pickled	6.2

Quadrato

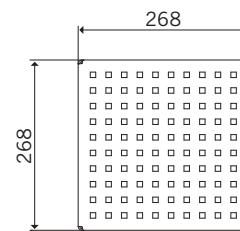

Part No	Description	Depth (mm)	Load Class	Finish	Weight (kg)
408036	Quadrato S/S 304	30	L15	Linished	1.8

Slot Cover

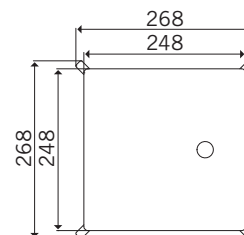

Part No	Description	Depth (mm)	Load Class	Finish	Weight (kg)
408039	Slot Cover S/S 304	30	M125†	Pickled	6.0

Note:

†Please refer to page 33 for PVC Infill required for applications at Load Class B125 (BS EN1253) and higher.

**Please refer to page 7 for explanation of symbols.

ACO Gully 218 available in 316 stainless steel. Please refer to ACO Stainless Steel Gully Systems product catalogue or contact the ACO Building Drainage Team on **01462 810421** or e-mail **abdestimating@aco.co.uk** for further details.

ACO Gully 218 Gratings for use with One Way and Two Way Gully Tops

Mesh

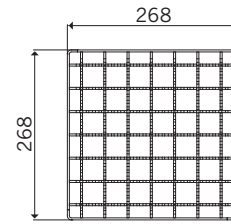
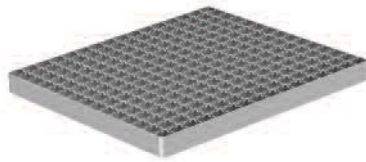

Part No	Description	Depth (mm)	Load Class	Finish	Weight (kg)
408035	Plain Mesh S/S 304	30	L15	Electropolished	2.1
408034	Slip Resistant Mesh S/S 304	30	L15	Electropolished	2.1

Heelsafe

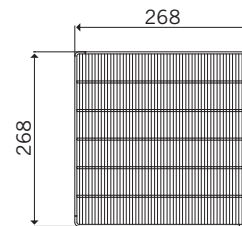

Part No	Description	Depth (mm)	Load Class	Finish	Weight (kg)
408040	Heelsafe S/S 304	30	L15	Linished	2.4

Ladder

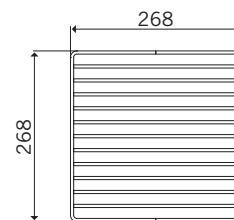

Part No	Description	Depth (mm)	Load Class	Finish	Weight (kg)
408037	Slip Resistant Ladder S/S 304	30	M125†	Pickled	4.3

Note:

†Please refer to page 33 for PVC Infill required for applications at Load Class B125 (BS EN1253) and higher.

**Please refer to page 7 for explanation of symbols.

ACO Gully 218 available in 316 stainless steel. Please refer to ACO Stainless Steel Gully Systems product catalogue or contact the ACO Building Drainage Team on **01462 810421** or e-mail **abdestimating@aco.co.uk** for further details.

ACO Modular 125+ Channel and Gully Installation Recommendations (details may vary depending upon application)

Step 1 Prepare for Modular 125+ installation



Modular 125 channels can be used in combination with gullies or directly connected to the installed pipework. The installation can be done in free space or within a trench, which is created by shuttering before the concrete is poured. Important dimensions to be taken into account in preparing for installation:

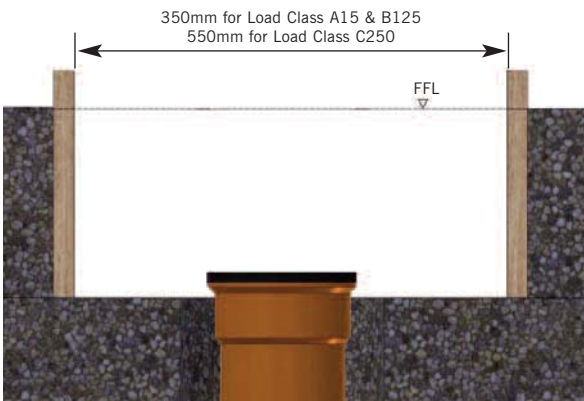

Installations designed for load classes A 15 and B125 allow a minimum of 30 mm of bedding material under the channel. When installing in a trench allow for 100 mm space on either side of the channel to create easy access to the levelling feet.

Installations designed for load class C250 allow a minimum of 200 mm of bedding material under the channel for concrete backfill support. To achieve the required height locally pack the levelling feet with suitable material (engineering bricks or similar). When installing in a trench allow a minimum of 200mm on either side of the channel.

Where it is not possible to provide the depth of surround as described above, a suitable mortar of Strength Class C30/C37 to BS EN 206-1 with a maximum aggregate size of 10mm may be used to support the channel following engineering advice.

Step 2 Installing the Modular 125+ channel



When using a gully under the modular channel, don't remove the FAT and FAT support ring.



Loosely assemble the Modular channel starting with the outlets.

LEAVE SPACER BARS IN PLACE AS THEY PROVIDE STRUCTURAL SUPPORT TO THE CHANNEL WHEN CONCRETED IN

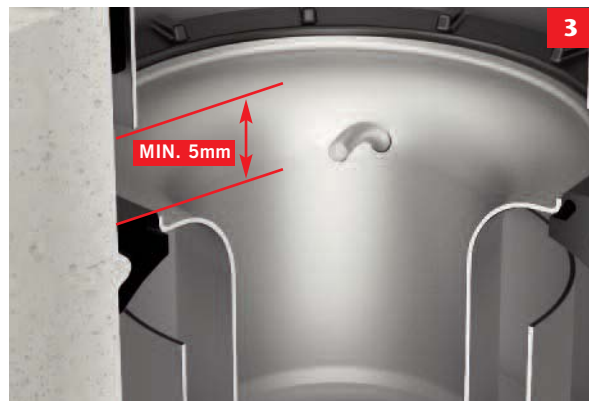

When using an ACO Gully please ensure the distance between the Modular channel outlet and the FAT Support ring is at least 5 mm.

ACO Modular 125⁺ Channel and Gully Installation Recommendations
 (details may vary depending upon application)

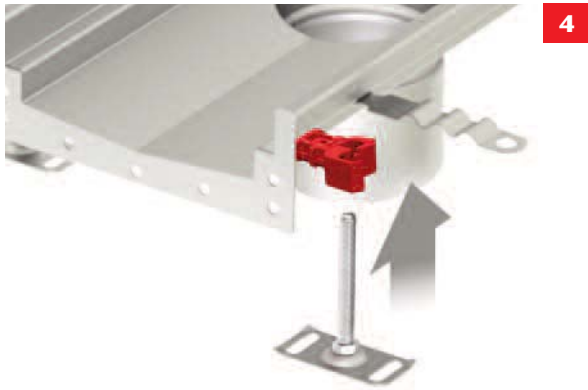

Open the plastic clip if larger height adjustment is required,

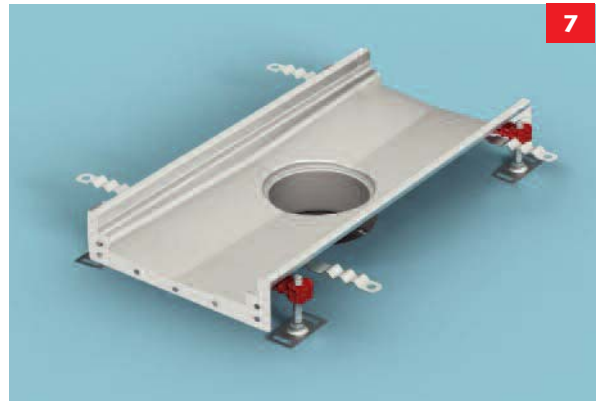

Once the outlet channel placed over the waste water pipe/gully orientate and level the channel in the required position.

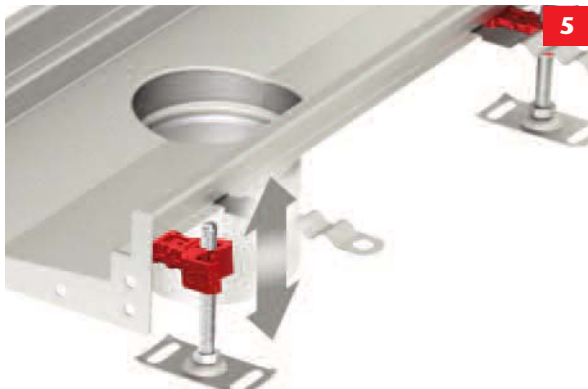

The levelling feet can be moved freely through the plastic clip.

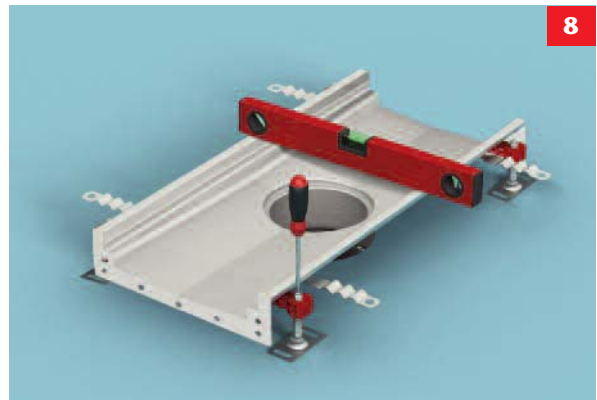

The levelling feet can still be adjusted to accommodate corrections following installation.

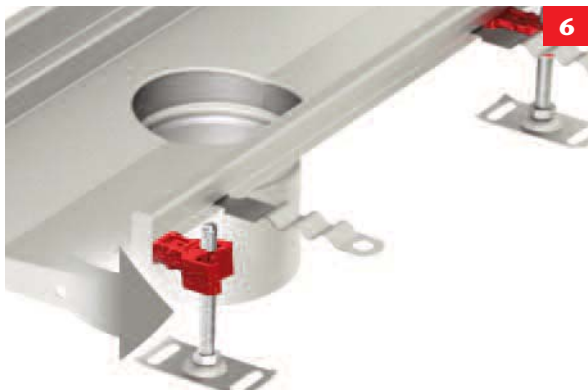

Close the clip when reaching the approximate intended level for the channel. Once the clip is completely closed, a fine adjustment of the levelling feet is possible by using a screwdriver.

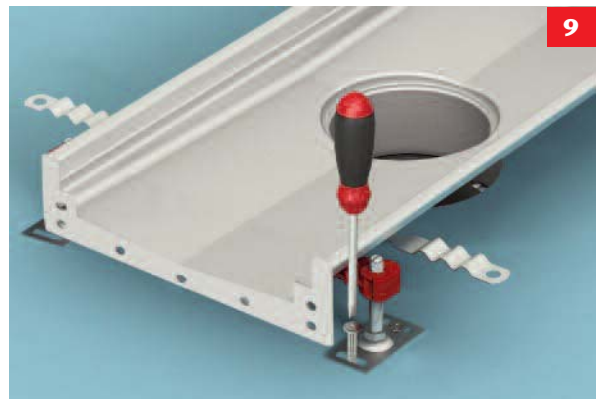

Once channel is in place fasten the levelling feet to the ground. Ensure, if applicable, that the PVC in-fill is fitted or, in the case of vinyl sheet floor covering, the ACO Vinyl Seal edge is installed.

ACO Modular 125+ Channel and Gully Installation Recommendations
(details may vary depending upon application)

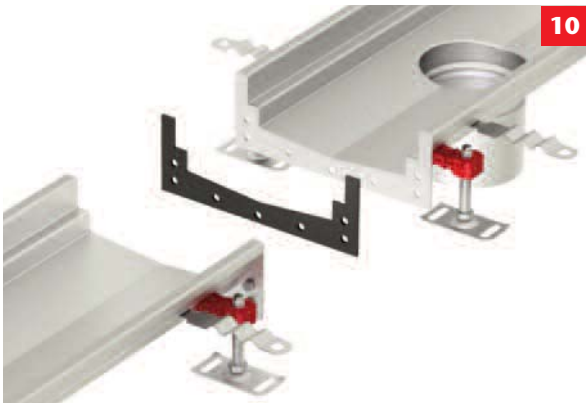

Ensure the gasket is placed in the right position.

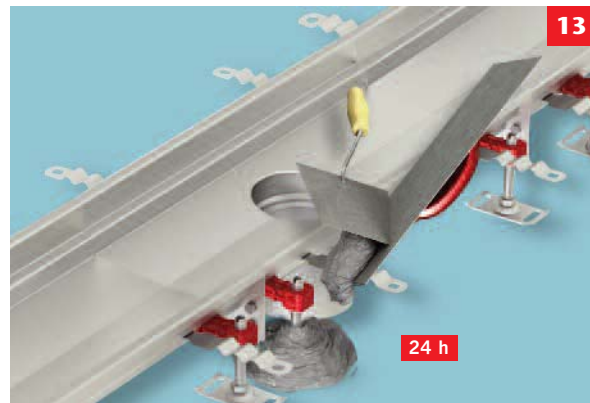

Weight the channel down or secure the levelling feet to the substrate, preventing the channel from lifting or floating.

Fully extend and twist the channel tangs to ensure good encourage into the surrounding haunching.



Align gasket and end plates of the channels and insert the bolts through the holes. Hand tighten the nuts on the bolts.



If the threaded post of the levelling feet interferes with the intended floor level cut the post down to appropriate level. Please cover the channel to prevent steel particles cross contaminating the stainless steel, as this can cause corrosion in the future.

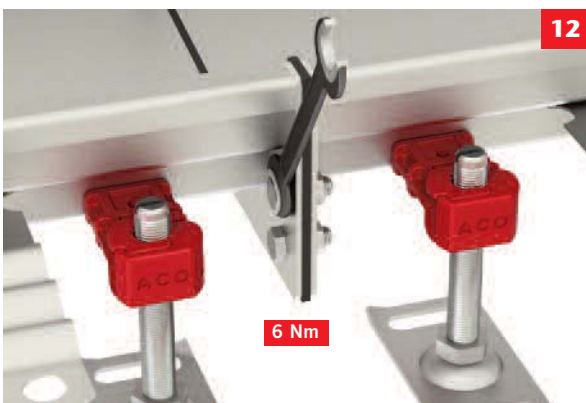

Ensure the position, line and level of the channel before fully tightening all joints.



When Modular channel is installed in combination with vinyl sheet floor covering using ACO Vinyl Seal **FIT THE ACO VINYL SEAL® PRIOR TO BACKFILLING**

For light and medium duty applications (up to load class C250) a suitable mortar of Strength Class 30/37 to BS EN 206-1 with a minimum aggregate size of 10mm should be used.

The spacer bars can be removed when the floor finishes are cured.

Floor finishes

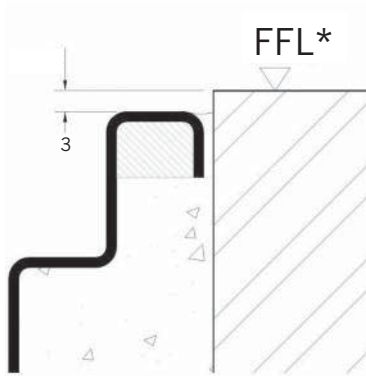

Block pavior/ hard standing finish

Lay block paviors on 300 mm wide epoxy surround to prevent movement. Set pavior 3 mm maximum above the channel edge.

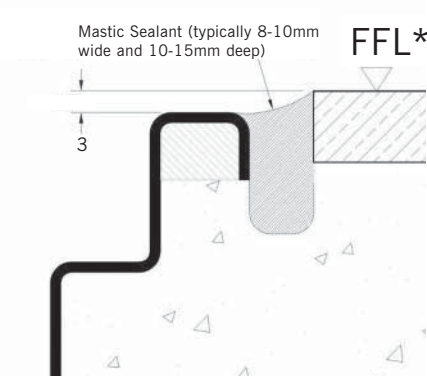

Tile/resin finish

Lay tiles/resin 3 mm maximum above the channel edge. Leave gap between edge of the channel and floor for mastic sealant of 8-10mm wide and 10-15mm deep.

In some cases it may be necessary to apply a suitable primerto the stainless steel before applying the mastic sealant. The sealant manufacturers' advice should be sought for each individual application.

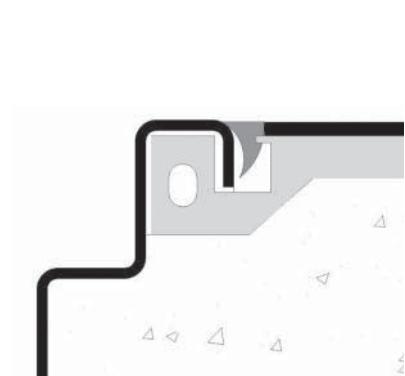

ACO Vinyl Seal®

See pages 47-48 for installtion of the ACO Vinyl Seal®

Grate Installation

Spacer bars provide rigidity during delivery, site handling and installation. They also prevent narrowing of the grating aperture during concreting.

Spacer bars should be left in position until immediately before the gratings are installed. The spacers are removed by striking them with a sharp horizontal blow using a mallet.

Gratings can be supplied with or without locking feature. Depending on the depth of the channel the locking construction is slightly different:

Lock Modular 125 gratings (50-65 mm depth)

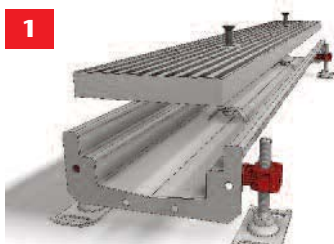

Included in supply:
 M8 Allen key
 ACO Modular 125+ Channel
 Grating
 2x M8 50mm long bolts per metre of channel

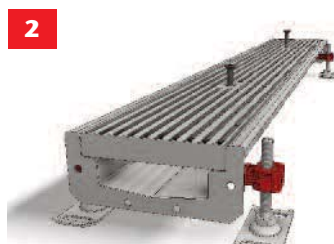

Ensure you have been supplied with the correct parts and place channel in the flooring.



Position the grating in the channel; this will sit either perfectly flush with the top of your channel or fractionally below.



Begin to screw the M8 bolts into the channel, this will tighten the grating in place using an M8 allen key.



Fully tighten the grating into the channel, however do not over tighten.



Test to ensure the grating is locked in place.

Lock Modular 125 gratings (65 + mm deep)



Included in supply:
 M8 Allen key
 ACO Modular 125+ Channel
 Grating
 2x MS 50mm long bolts per metre of channel
 2x Locking bar

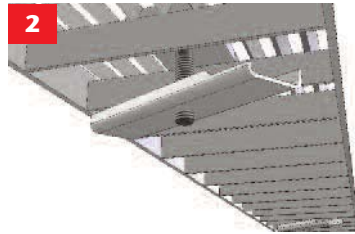

Ensure you have been supplied with the correct parts and place channel in the flooring.

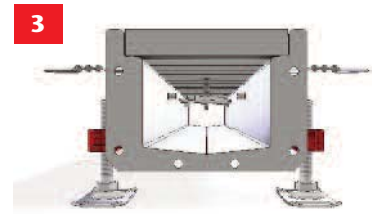

Insert bolt into the grating and screw on locking bar while the grating is outside the channel. Only screw on loose. The locking bar with the lower side has to be in front of the of the higher side when turning clockwise.

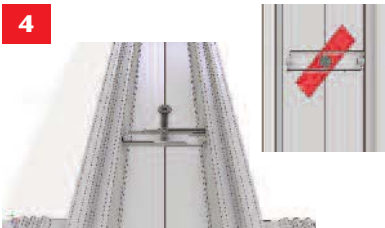

Place the grating in the channel and begin to tighten the M8 bolts. This will turn the locking bar within the channel and catch on the pins within the channel. The lower side of the locking bar will pass under the pin and the high side will lock against the pin.

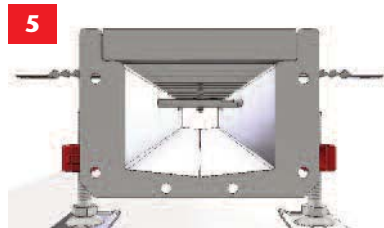

Fully tighten the grating into the channel and test to ensure the grating does not move.



The locking bars should sit securely as seen in the bottom picture on the left, fitting your grating securely in place.

Lock Modular 125 gratings in channel with outlet:



Included in supply:
 M8 Allen key
 ACO Modular 125+ Channel
 Grating
 1 x M8 50mm long bolts per metre of channel
 1 x Locking bar



Ensure you have been supplied with the correct parts and place channel in the flooring.
 Place grating in channel and insert the locking bar under the pins within the channel. Loosely tighten the locking bar, by hand so it is held in position to be tightened further.



Tighten the M8 bolt further using the M8 allen key so the locking bar pulls up against the pins and the side of the channel. This will secure the grating in place.
 Fully tighten the grating into the channel and test to ensure the grating does not move.



The locking bar should sit securely (in a Z shape) as seen in the bottom picture on the left, fitting your grating securely in place.

CLEANING:

Remove all protective tape from the channel edge and clean the surface with a solvent if necessary to remove any adhesive residue.

Wash and clean the channel (and gully if applicable), empty silt or sediment baskets and refit grates.

ACO Vinyl Seal® Installation Recommendations

Sealing Vinyl Sheet Flooring to Drainage Channels and Gullies

Vinyl/flexible sheet is a common flooring finish in many of the areas where stainless steel drainage channels and gullies are required.

Historically the standard method of joining vinyl/flexible sheet flooring to drainage channels and gullies was by a mechanical clamping system. Although functional, this method can be cumbersome to install and increases the potential for areas of bacterial growth.

In order to overcome the frequently encountered problems of achieving watertight and bacteria free seals, ACO Building Drainage have developed and patented the ACO Vinyl Seal®, a unique solution that enables quick, easy and cost effective installation. It also provides a completely watertight and bacteria free seal.

ACO Vinyl Seal® requires no additional tools or skills other than those required for the professional fitting of vinyl sheet flooring.

ACO Vinyl Seal® is not suitable for wooden or suspended floors. Contact the ACO Building Drainage team on 01462 801421 or email abdestimating@aco.co.uk for assistance.

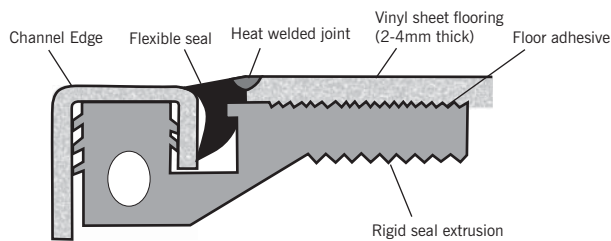

Step 1 Remove Protective Tape

Remove channel protective tape prior to fixing extrusion.

Step 2 Cut Rigid Seal Extrusion



Cut grey rigid seal extrusion to suit ensuring any mitres are cut accurately otherwise pressure points may appear in the finished floor in use.

Step 3 Clip Rigid Seal into Channel



Using Sheet Plier Grip Wrench clip the rigid seal extrusion into the underside of channel.

Step 4 Cut Notches into Rigid Seal



Where there are joint plates in the channel run cut a notch out of the rigid seal extrusion as shown to enable the extrusion to be clipped to the underside of the channel.



Picture shows the rigid extrusion cut and fitted prior to the fitting of the black flexible seal.

ACO Vinyl Seal® Installation Recommendations

Step 5 Position Black Flexible Seal



Insert the black flexible seal inbetween channel edge and rigid seal extrusion making sure that the curved concave section of the seal faces TOWARDS the channel edge and that the groove in the black flexible seal engages with the notch on the rigid seal extrusion. (It may help to lubricate the flexible seal when inserting using a water soluble soapy solution).

Step 6 Insert Black Flexible Seal



Using the Sheet Plier Grip Wrench, proceed along the channel edge inserting the black flexible seal.

Step 7 Corner Detail



When fitting around a corner, the black flexible seal should be kept in one piece to minimise joints.



Picture shows the rigid seal extrusion and black flexible seal fitted prior to screeding / back filling.

Step 8 Install Channel

Install the channel into the ground ensuring the flooring screed is flush to the top edge of the rigid seal extrusion. Protect the channel and seal assembly from splashes of concrete or screed.

Step 9 Grouting

Grout any voids at connecting PVC joints and mitred corners to ensure a continuous fully supported surface.

Step 10 Prepare Rigid Seal Edge

Prior to laying the vinyl/flexible sheet flooring, peel the protective film from the rigid seal extrusion (a knife may be required to cut the film adjacent to the flexible seal) and ensure all surfaces are clean and dry.

Step 11 Prepare Vinyl/Flexible Sheet

When preparing the vinyl/flexible sheet material and floor surface, apply a compatible adhesive* to the top surface of the rigid seal extrusion taking care not to apply adhesive to the flexible seal. This is to ensure the vinyl sheet floor is reliably anchored over its full area.

*Altrofix 19 two part water resistant eurothane adhesive.

Step 12 Welding

Lay the sheet flooring against the flexible seal edge and prepare the welded joint between the flexible seal and vinyl/flexible sheet flooring as normal by scoring the sheet/seal joint to approximately half the depth of the sheet flooring thickness.

Either in-colour or black welding filler rod may be used to weld the joint. Remove surplus weld material from the joint using a spatula when the welded joint has cooled.

Care and Maintenance of ACO Modular 125+

Care During Installation

Surface contamination and the formation of deposits must be prevented during installation in order to maintain a durable and hygienic surface. These deposits may be minute particles of iron or rust from other sources used in the building environment. Wire brushes and wire wool **must not** be used to remove marks and cement spillages as this will introduce iron impurities to the material surface. Care must also be taken when storing, erecting or cutting carbon steel near to stainless steel.

Factors Affecting Maintenance

Cleaning before handing over to the client should present no special problems if care during installation has been taken, although more attention may be required if the installation period has been prolonged.

Where surface contamination is suspected, immediate attention to cleaning after site fixing will encourage a trouble free product.

Although robust, all grades of stainless steel will stain and discolour due to surface deposits and therefore can never be accepted as completely maintenance free. In order to

achieve maximum corrosion resistance, the surface of the stainless steel must be kept clean. Provided the grade of stainless steel and the surface finish are correctly selected, and cleaning schedules carried out on a regular basis, excellent performance and long service life are assured.

Industrial and even naturally occurring atmospheric conditions can produce deposits which can be corrosive, e.g.: salt deposits from marine conditions.

High humidity environments (e.g. swimming pools) increase the speed of discolouration and therefore require maintenance on a more frequent basis.

Modern processes use many cleaners, sterilisers and bleaches for hygienic purposes which when used in accordance with manufacturers instructions are safe, but if used incorrectly (e.g. warm or concentrated) can cause discolouration and corrosion on the surface of all stainless steel.

Strong acid solutions used to clean masonry and tiling of buildings should never be permitted to come into contact with stainless steel. If this should happen the acid solution must be removed immediately by copious application of water.

Maintenance Programme

Advice is often sought concerning the frequency of cleaning stainless steel and the answer is quite simple: clean the metal when it is dirty in order to restore its original appearance. This may vary from once to four times a year for external applications or it may be once a day for an item in hygienic or aggressive situations (food, beverage, pharmaceutical and chemical applications).

Frequency and cost of cleaning is lower with stainless steel than with many other materials, and will often outweigh the initial higher cost of this superior product.

Cleaning Methods

ACO Modular 125+ system components are easy to clean. Washing with soap or a mild detergent and warm water followed by a clear water rinse is usually adequate. An enhanced aesthetic appearance will be achieved if the cleaned surface is wiped dry.

Precautions

Acid cleaners should be used for cleaning **only** when other methods have proved unsatisfactory. Manufacturers directions should be followed.

Problem	Cleaning Agent	Recommendation
Routine cleaning	Soap or mild detergent and water (e.g.: washing up liquid)	Sponge, rinse with clean water, wipe dry if necessary
Fingerprints	Soap and warm water or organic solvent (e.g.: acetone, alcohol)	Rinse with clean water, wipe dry if necessary
Stubborn stains and discolouration	Mild cleaning solutions (e.g.: Cif, Goddard Stainless Steel Care)	Clean after with soap and water, rinse with clean water and dry, if necessary
Oil and grease marks	Organic solvents (e.g.: acetone, alcohol)	After solvent use clean with soap and water, rinse with clean water and dry, if necessary
Rust and corrosion	Most mild corrosion and staining effects can be removed by the application of commercially available metal polishes. Check manufacturer's details before use	Rinse well with copious amounts of clean water (precautions for acid cleaners should be observed)
Scratches on brushed finishes	Household synthetic fibre scouring pads (e.g.: Scotch Brite fibre pad)	Apply in direction of brushed finish. Clean with soap or detergent as per routine cleaning. Never use ordinary steel wool as iron particles can become embedded in the surface being cleaned and cause corrosion

Always read instructions on proprietary cleaning agents!

Stainless Steel Explained

Stainless steel is the name given to a wide range of steels which have the characteristics of greatly enhanced corrosion resistance over conventional mild and low alloy steels.

The enhanced corrosion resistance of stainless steel essentially comes from the addition of at least 11% chromium, however most stainless steels commonly used contain around 18% chromium. Other significant alloying elements include nickel and for superior corrosion resistant properties, molybdenum.

For ACO Building Drainage applications, the principal properties of stainless steel may be summarised as follows:

- Durable and corrosion resistant in highly aggressive environments.
- Hygienic, easily cleaned surfaces.
- Aesthetically attractive surface finish.
- Good forming and fabrication characteristics.
- Excellent strength and resistance to oxidation at high temperatures.

All these make stainless steel an obvious first choice material for demanding applications.

Stainless Steel Families

Stainless steel is used across a wide spectrum of engineering applications and this has led to the development of the vast range of different types of stainless steels that are now available.

Austenitic Stainless Steel is the most widely used and encompasses the generic 304 and 316 grades of material. These materials are used in the ACO Building Drainage manufacturing process and are ideal for applications including food processing, leisure, dairy, brewing, pharmaceutical, chemical and petrochemical industries.

304 grade stainless steels contain around 18% chromium and 10% nickel and provides excellent corrosion resistance. For applications where superior corrosion resistance properties are required under extreme conditions particularly where chlorides are involved, 316 grade stainless steels are used and contain around 17%



chromium, 12% nickel and 2.2% molybdenum.

Unlike all other grades of stainless steels, austenitic grades are non-magnetic and as a consequence magnetic particles are not attracted to the system surfaces which otherwise would encourage both contamination and corrosion.

Ferritic, Martensitic and duplex stainless steels are unsuitable for drainage products.

Stainless Steel Corrosion Resistance

The single most important property of stainless steels and the reason for their existence and widespread use, is their natural corrosion resistance. In spite of their name, stainless steels can both 'stain' and corrode if used incorrectly.

The reason for the good corrosion properties is due to the formation of a very thin, invisible oxide film that forms on the surface of the material in oxidising environments such as the atmosphere and water.

This film is a chromium-rich oxide which protects the steel from attack in aggressive environments. As chromium is added to a steel, a rapid reduction in the corrosion rate is observed because of this protective film. In order to obtain a compact and continuous passive film, a chromium content of at least 11% is required. Passivity increases fairly rapidly with increasing chromium content up

to about 17% chromium.

The most important alloying element is therefore chromium, but a number of other elements including nickel, molybdenum and nitrogen also contribute to the corrosion resistance properties of stainless steels. Other alloying elements may also be added to enhance the corrosion resistance in particular environments.

Stainless steels must oxidise in order to form the passive, chromium-rich oxide film. Stainless steels have a very strong tendency to passivate and only a small amount of oxidising agents are needed for passivation - air and water are sufficient to passivate stainless steels and indeed, this oxide film is spontaneously regenerated when exposed to oxygen. An important factor to note is that the passive film is self-healing, so when the material is cut or machined or, should chemical or mechanical damage occur, the passive film will 'heal' or re-passivate in oxidising environments - unlike a painted finish on mild steel.

Selection of the correct grade of material for each application is an important factor in the design process. It is important to note that even 316 grades of stainless steel are not immune to all kinds of chemical attack; use of reducing solutions such as hydrochloric and sulphuric acids particularly when in concentrated and/or hot form, requires careful consideration. See corrosion resistance chart on pages 52 and 53.

Stainless Steel Finishing Processes

A stainless steel finish should appear clean, smooth and faultless. This is obvious when the steel is used for such purposes demanding stringent hygiene or decorative trim applications, but a fine surface finish is also crucial in respect to its corrosion resistant properties.

The corrosion resistance properties of stainless steel are achieved by the spontaneous formation of a very thin chromium-rich oxide layer over the surface of the material. Unfortunately, surface defects and imperfections introduced during the manufacturing process may drastically disturb the self healing process of the passive layer and subsequently reduce the corrosion resistance of the material.

In the manufacturing process it is welding that creates the greatest challenge to corrosion resistance.

Untreated Stainless Steel



After welding stainless steel, a bluish high temperature oxide film can be seen which has substantially inferior corrosion protection properties compared to the original passive layer. Immediately beneath this blue oxide film is a thin layer of chromium depleted metal which makes the metal surface susceptible to corrosion. Post weld treatment is, therefore, very important to restore the corrosion protection properties and is effectively achieved by removing the blue high temperature oxide film and chromium depleted layer to restore the surface of the material. This 'cleaning' is essentially a controlled corrosion process using chemicals, this will restore not only its original corrosion resistance performance but also the high quality aesthetics.

The single most important property of stainless steels and the reason for their existence and widespread use, is their natural

corrosion resistance. In spite of their name, stainless steels can both 'stain' and corrode if used incorrectly.

The reason for the good corrosion properties is due to the formation of a very thin, invisible oxide film that forms on the surface of the material in oxidising environments such as the atmosphere and water.

ACO Pickle Passivation Plant



All ACO Building Drainage products are subjected to specialised treatment to ensure the material retains the maximum resistance to corrosion.

The chemical processing methods used in the ACO Building Drainage process are pickle passivation and electropolishing. ACO resources include the largest pickle passivation plant in Europe.

Pickle Passivation

The standard ACO Building Drainage manufacturing process uses the pickle passivation chemical finishing process to restore the products to their full optimum corrosion resistant state without damaging the surface finish. This is considered the best method for cleaning welded joints.



Pickle Passivation is a two-phase process. Pickling removes both the bluish high temperature oxide film and the chromium depleted layer and is achieved by placing the components in a pickling bath containing a

mixture of nitric acid and hydrofluoric acid.

The second phase is passivation and in many ways is similar to the pickling process. During this process the components are placed in a bath containing only nitric acid. This treatment strengthens the passive layer and also removes any iron impurities that may have become embedded in the surface of the stainless steel during the manufacturing process.

This treatment is important where mechanical cleaning of the components has taken place with the use of wire brushes, grinding wheels and files where iron particles from other materials may contaminate the stainless steel surface.

Electropolishing



Electropolishing is ideal for producing a uniform, highly reflective lustre with an extremely smooth finish even on the most complex product contours. This is a well proven method of polishing and is achieved by an electro-chemical process which is essentially the reverse of electroplating.

The components are immersed in a bath of electrolyte containing phosphoric acid where the components become the anode of a direct current electrical circuit. The process is characterised by the selective attack on the surface of the components whereby upstanding roughnesses are preferentially dissolved and will yield a progressively smoother, brighter surface.

For pharmaceutical and food processing industries, bacterial resistance is considerably improved by the electropolishing process.

Certain gratings within the ACO Building Drainage range are electropolished as standard. All stainless steel products can be electropolished if required to special order.

Corrosion Resistance Chart

Reagent	Stainless Steel 304	Stainless Steel 316	EPDM	Neoprene Gasket	Viton Gasket
Acetic Acid 20%	●	●	●	?	●
Acetic Acid 80%	●	●	●	X	●
Acetone	●	●	●	●	X
Alcohol (Methyl or Ethyl)	●	●	●	●	?
Aluminium Chloride	?	?	●	●	●
Aluminium Sulphate	●	●	●	●	●
Ammonia Gas (Dry)	●	●	~	●	~
Ammonium Chloride	?	?	●	●	●
Ammonium Hydroxide	●	●	●	●	●
Ammonium Nitrate	●	●	●	●	●
Ammonium Phosphate	●	●	●	●	●
Ammonium Sulphate	?	●	●	●	●
Ammonium Sulphide	●	●	~	~	~
Amyl Chloride	●	●	X	~	?
Aniline	●	●	?	X	●
Barium Chloride	●	●	●	●	●
Barium Hydroxide 10%	~	~	●	●	●
Barium Sulphate	●	●	●	●	●
Barium Sulphide	~	~	●	●	●
Beer	●	●	●	●	●
Beet Sugar Liquors	●	●	●	●	●
Benzene	●	●	X	X	●
Benzoic Acid	●	●	X	●	●
Bleach -12.5%Active C1	~	~	●	X	X
Boric Acid	●	●	●	●	●
Bromic Acid	?	?	~	~	~
Bromine Water	X	X	~	X	~
Butane	●	●	X	●	●
Calcium Carbonate	●	●	●	●	●
Calcium Chloride	X	?	●	●	●
Calcium Hydroxide	?	●	●	●	●
Calcium Hypochlorite	X	?	?	X	●
Calcium Sulphate	●	●	●	~	●
Cane Sugar Liquors	~	~	●	●	●
Carbon Acid	~	~	●	●	●
Carbon Bisulphide	●	●	X	X	●
Carbon Dioxide	●	●	●	●	●
Carbon Monoxide	●	●	●	●	●

Reagent	Stainless Steel 304	Stainless Steel 316	EPDM	Neoprene Gasket	Viton Gasket
Carbon Tetrachloride	?	?	X	X	●
Caustic Potash	●	●	●	~	●
Caustic Soda	●	●	●	●	●
Chloride (Dry)	?	?	●	X	●
Chloride (Wet)	X	X	X	X	?
Chloroacetic Acid	~	●	?	X	●
Chlorobenzene	●	●	X	X	●
Chloroform	?	?	X	X	●
Chrome Acid 50%	X	X	?	X	●
Chromic Acid 10%	●	●	X	X	●
Citric Acid	?	●	●	●	●
Copper Chloride	X	X	●	●	●
Copper Cyanide	●	●	●	●	●
Copper Nitrate	●	●	~	●	●
Copper Sulphate	●	●	●	●	●
Cottonseed Oil	~	~	X	●	●
Cresol	~	~	X	X	X
Cyclohexanone	?	●	●	X	X
Cyclohexanol	~	~	X	●	X
Dimethyleaniline	~	~	?	●	●
Dionylphalate	~	~	?	X	X
Disodium Phosphate	~	~	●	X	●
Distilled Water	●	●	●	●	●
Ethyl Acetate	●	●	?	X	X
Ethylene Chloride	●	●	X	X	?
Ethylene Glycol	●	●	●	●	●
Fatty acids (Cb)	●	●	X	?	●
Ferric Sulphate	●	●	●	●	●
Fluorene Gas (wet)	X	X	●	X	?
Formaldehyde (37%)	●	●	●	●	●
Formic Acid (90%)	X	●	●	●	?
Freon 12	●	●	●	●	●
Fruit Juices and Pulp	?	●	~	●	●
Furfural	●	●	X	X	X
Gasoline (Refined)	●	●	X	●	●
Glucose	●	●	●	●	●
Glycerine	●	●	●	●	●

The corrosion resistance information contained within this table is indicative only.

All data is based on reactions noted at an ambient temperature of 20°C. Higher temperatures will generally reduce the corrosion resistance of the materials.

Please contact ACO Building Drainage if

guarantees are required of specific material suitability.

We shall arrange for tests to be undertaken with the reagent to establish the chemical resistance of the materials. Other gasket and sealing ring materials are available. Please contact us for further information.

- Recommended
- ? Suitable. However, contact ACO Building Drainage for further advice.
- X Not recommended
- ~ No data available

Corrosion Resistance Chart

Reagent	Stainless Steel 304	Stainless Steel 316	EPDM	Neoprene Gasket	Viton Gasket
Hydrobromic Acid (20%)	X	X	●	X	●
Hydrochloric Acid (40%)	X	X	X	●	●
Hydrocyanic Acid	●	●	?	●	●
Hydrogen Peroxide (90%)	●	●	X	X	●
Hydroquinone	~	~	X	●	●
Hypochlorous Acid	~	~	X	X	●
Iodine	X	?	?	X	●
Kerosene	●	●	X	●	●
Lactic Acid 25%	●	●	●	●	●
Linseed Oil	●	●	X	●	●
Liqueurs	~	~	?	X	●
Magnesium Chloride	?	?	●	●	●
Magnesium Sulphate	●	●	●	●	●
Maleic Acid	?	?	X	X	●
Methyl Chloride	?	?	X	X	●
Methyl Ethyl Ketone	~	~	●	X	X
Milk	●	●	●	●	●
Minerals Oils	~	~	X	●	●
Muriatic Acid	X	X	?	●	●
Nickel Chloride	?	?	●	●	●
Nickel Sulphate	●	●	●	●	●
Oils and Fats	●	●	?	?	●
Oleic Acid	●	●	●	?	●
Oleum	~	~	X	X	●
Oxalic Acid	?	?	●	X	●
Palmitic Acid 10%	~	~	●	X	●
Perchloric Acid 10%	X	X	?	●	●
Perchloric Acid 70%	X	X	?	X	●
Petroleum Oils (Sour)	●	●	X	●	●
Phenol 5%	●	●	?	X	●
Phosphorous Trichloride	●	●	●	X	●
Photographic Solutions	?	?	●	●	●
Picric Acid	●	●	●	●	●
Plating Solutions	~	~	~	X	●
Potassium Carbonate	●	●	●	●	●
Potassium Chloride	●	●	●	●	●
Potassium Cyanide	●	●	●	●	●
Potassium Dichromate	●	●	●	●	●
Potassium Hydroxide	●	●	●	●	●
Potassium Permanganate	●	●	●	●	●
Potassium Sulphate	●	●	●	●	●
Propane Gas	~	~	~	?	●
Propyl Alcohol	~	~	●	●	●

Reagent	Stainless Steel 304	Stainless Steel 316	EPDM	Neoprene Gasket	Viton Gasket
Sea Water	X	?	●	●	●
Sewage	?	?	●	●	●
Silver Nitrate	●	●	●	●	●
Silver Sulphate	●	●	●	●	X
Sodium Bicarbonate	●	●	●	●	●
Sodium Bisulphite	●	●	●	●	X
Sodium Carbonate	●	●	●	●	●
Sodium Cyanide	●	●	●	●	●
Sodium Ferrocyanide	~	~	?	●	●
Sodium Hydroxide	●	●	●	●	●
Sodium Hypochlorite	?	●	?	●	●
Sodium Sulphate	●	●	●	●	●
Sodium Sulphide	?	●	●	●	●
Sodium Sulphite	?	●	●	●	●
Sodium Thiosulphate	●	●	●	●	●
Stannous Chloride	?	?	X	●	●
Stearic Acid	●	●	?	●	●
Sulphite Liquor	~	~	?	●	●
Sulphurous Acid	?	?	?	X	●
Sulphur	?	●	~	●	●
Sulphur Dioxide (Dry)	?	●	●	X	●
Sulphur Dioxide (Wet)	?	●	●	●	●
Sulphuric Acid 50%	X	X	?	●	●
Sulphuric Acid 70%	X	X	?	●	●
Sulphuric Acid 93%	X	X	?	X	●
Tannic Acid	●	●	●	●	●
Tanning Liquors	●	●	●	●	●
Tartaric Acid	~	~	?	●	●
Toluene	~	~	X	X	X
Trichloroethylene	●	●	X	X	X
Triethanolamine	~	~	●	●	X
Trisodium Phosphate	~	~	●	●	●
Turpentine	●	●	X	X	●
Urea	●	●	●	●	●
Urine	●	●	●	●	●
Vinegar	●	●	●	●	●
Water (Fresh)	●	●	●	●	●
Water (Mine)	●	●	●	●	●
Water (Salt)	?	?	●	●	●
Whisky	●	●	●	●	●
Wines	●	●	●	●	●
Xylene	~	~	X	X	X
Zinc Chloride	X	X	●	●	●
Zinc Sulphate	?	●	●	●	●

System Characteristics

ACO Building Drainage – Modular 125+ Linear Drainage System

A range of austenitic stainless steel linear drainage channels and accessories with level and sloping invert channels, gratings and accessories.

Suitable for linear drainage in changing rooms, leisure, showers, wet rooms, kitchens, food and beverage processing, hospitals and healthcare, abattoirs, chemical plant and washdown areas.

Manufacturer:	ACO Building Drainage, ACO Business Centre, Caxton Road, Bedford, Bedfordshire MK41 0LF Tel: 01462 810400 Email: abdestimating@aco.co.uk
Material:	304 grade austenitic stainless steel to BS EN 10088 pickle passivated.
Product:	ACO Modular 125+ linear drainage system to BS EN 1433 Load Class A15 to C250.
Literature:	Contact ACO Building Drainage department for details.
Link to web:	http://www.acobuildingdrainge.com/modular.php
Design:	ACO Building Drainage Technical Services provide design and specification.

Model Specification Clause

For relevant NBS Specification, refer to NBS section for floor channel systems relating to Clause 310 Floor Channels in R11 - Above ground foul drainage channels.

Note: A specification in NBS format is available to download from www.thenbs.com or www.acobd.co.uk

EU Conformity

The ACO Modular 125+ system is fully certified to BS EN 1433:2002 and CE marked in accordance with the Construction Products Regulation.

Declarations of Performance are available via our website www.acobd.co.uk or on request, please contact ACO Building Drainage Design Services Team on 01462 810431 for further information.



Associated ACO Building Drainage Product Ranges

ACO Stainless Steel Gully Systems

ACO Stainless Steel Gullies are manufactured as standard in both stainless steel grade 304 and 316, and are pickle passivated for optimum durability and corrosion resistance. All ACO gullies are designed for optimum hygiene performance and meet the stringent demands of modern hygienic installations. Available in various ranges to suit any application, each range offers a selection of products to meet all industrial and commercial drainage requirements. ACO stainless steel gullies can be used in either a standalone single point gully application or, with other ACO products, such as ACO Modular 125⁺, ACO PIPE[®] and ACO Engineered Solutions channel drainage, to provide a complete drainage solution.



ACO PIPE[®]

ACO PIPE[®] is manufactured from thin-wall austenitic stainless steel in grades 304 and 316 and is pickle passivated for optimum durability and corrosion resistance. ACO Pipe[®] is available in a wide range of socketed waste pipework products and accessories for above and below ground rainwater and industrial wastewater drainage applications. Used together with other ACO products it creates a perfect system and one stop sustainable drainage solution with unique advantages to the customer – lightweight, easy installation, low thermal expansion co-efficient, sustainable material, hygienic, near zero maintenance. When used with ACO stainless steel gullies and channel systems it provides a unique system for building drainage.



ACO DeckLine 125

ACO DeckLine 125 is a shallow invert hot-dipped galvanised steel linear drainage system for applications up to and including Load Class C 250. It is ideally suited for parking decks and areas such as structural slabs or where excavation depth is limited. Available off the shelf ACO DeckLine is durable, 100% watertight and easy to install. ACO DeckLine 125 is tested and certified to BS EN 1433.



Notes



ACO Technologies plc

- ACO Building Drainage
- ACO Water Management
Civils + Infrastructure
Urban + Landscape
- ACO Sport
- ACO Wildlife



ACO Building Drainage

A division of ACO Technologies plc
ACO Business Centre
Caxton Road
Bedford
Bedfordshire
MK41 0LF
Tel: 01462 810400

e-mail: abdinfo@aco.co.uk
www.acobd.co.uk

The ACO Group: A strong family you can depend on.

© May 2017 ACO Technologies plc. All reasonable care has been taken in compiling the information in this document. All recommendations and suggestions on the use of ACO products are made without guarantee since the conditions of use are beyond the control of the Company. It is the customer's responsibility to ensure that each product is fit for its intended purpose, and that the actual conditions of use are suitable. This brochure and any advice is provided by ACO Technologies plc (the Company) free of charge and accordingly on terms that no liability including liability for negligence will attach to the Company or its servants or agents arising out of or in connection with or in relation to this brochure or any such advice. Any goods supplied by the Company will be supplied solely upon its standard conditions of sale, copies of which are available on request. The Company's policy of continuous product development and improvement renders specifications liable to modification. Information provided in this brochure is therefore subject to change without prior notification.